

KARUNIA BAJA PERSADA



Certified Company  
Cert No. : 16 00 K 16140

07-0950-1989

• strength and innovation •

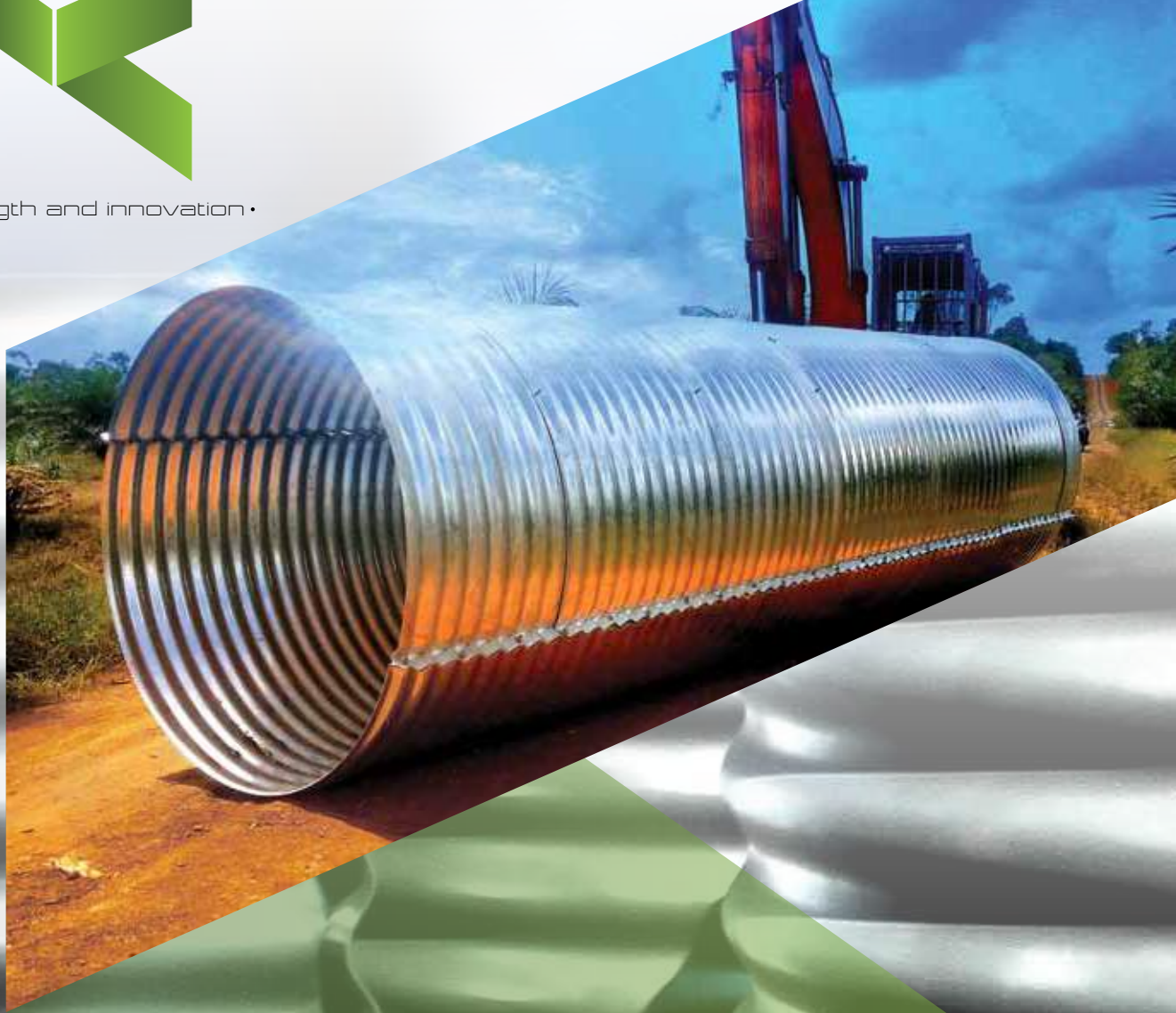

# ECONOMICAL, QUICK AND EASY

CATALOGUE

## PT KARUNIA BAJA PERSADA

Jl. Raya Narogong Km. 6, No. 75, Kampung Rawa Roko RT 03 / RW 02  
Kelurahan Bojong Rawa Lumbu, Kecamatan Rawa Lumbu  
Kota Bekasi, Jawa Barat 17116 Indonesia

**Corrugated Steel, Flex Beam Guardrail, Steel Pole, Pipe Railing.**

 021 - 82400790

 021 - 22103215

 [sales@ptkbp.com](mailto:sales@ptkbp.com)

 [www.ptkbp.com](http://www.ptkbp.com)



# OUR COMMITMENT



KBP will build solid reputation by providing professional support and innovative as well as corrugated steel products with the best quality in Indonesia

We combine Technology and Science to give you the advise and support you need.

You can count on our solutions to help you overcome your biggest challenges. We use Strategic problem-solving and engineering expertise to lead you From design, erection until Application.

We welcome the opportunity to discuss your next project. Please contact your KBP Technical Sales Representative for assistance on **021-82400790**



# CORRUGATED STEEL



## Consider the many benefits of specifying corrugated steel Products :

### STRENGTH

The inherent strength of Corrugated steel pipe is derived from the mechanical properties of steel combined with the steel-soil interaction. Advanced steel manufacturing process ensures all material meet specification every time. The steel-soil interaction allows for high-rig compression strength in a relatively thin-walled structure. Corrugated steel pipe absorbs and transfers the vertical live and dead loads to the surrounding soil around the entire circumference of the pipe.

### Durability

With more than 50 years of service, much is known about the factors which affect the durability of Corrugated Steel Pipe. Using the right mix of high performance coatings, installation techniques, backfill and pipe materials, Corrugated Steel Pipe structures can be designed to provide a service life of 50 years or more.

### Low Cost

Corrugated steel pipe is more cost effective than other drainage structures when all aspects of the application are considered.

### Reduced Maintenance

Although all roadway structures require Periodic inspections, Corrugated Steel Plate structure typically requires less maintenance than a bridge.

### Control Stream Flows

Corrugated Steel Plate structures can be used to control and redirect meandering stream flows which might otherwise threaten to undercut bridge piers and abutments.

### Ideal

Corrugated Steel is ideal for new site developments, council and municipal stream crossings, as well as urban rehabilitations. It maintains natural streambeds and reduces environmental impacts.

**Given its many advantages, a corrugated steel pipe structure often represents the best value for concrete structure and bridge replacement.**

## SPECIFICATION

We have included SPECIFICATION information on some of our most common Products as a quick-reference guide for our clients and partners. If you need additional specification on our products CONTACT KBP representative.

**Table 1**

ITEM	DESCRIPTION	AASHTO	ASTM	AS	SNI
Design	Structural design of corrugated steel pipe and structural plate pipe	Bridge Section 12	A-796	AS 2041 AS 2042	SNI 07-0950
Galvanize	Steel base steel with 2 oz. per ft <sup>2</sup> . Zinc coating for corrugated steel pipe	M-218	A-796	AS 1650	SNI 07-7033
Cold Applied Bituminous Coating	Fibrated mastic or asphalt base coatings of various viscosities for field or shop coating of corrugated pipe or structural plate	M190	A-849 ASTM D147	AS2758.2 AS1289	SNI-06-6452-2000 SK SNI-M-09-1991-03 SK SNI-M-1011994-04
Installation	Corrugated Steel Pipe	Bridge Section 26	A-798	AS 2041 AS 2042	SNI 07-0950

## APPLICATION

Corrugated Steel Pipe offers some very distinct advantages over other drainage product. This unique product offers a wide variety of sizes, shapes, profiles, and thicknesses, coupler types, fittings, a range lengths, and special coatings.

Corrugated Steel pipe is so versatile that it's not just for traditional drainage anymore! Applications include :

- Culvert
- Small Bridges
- Storm Drainage
- Storm Water Detention
- Underpasses and Cattle Crossings
- Utility Conduits
- Cisterns
- Mine Portals
- Pipeline Crossings
- Stockpile Tunnels
- Road and Rail Grade Separations
- Cut and Cover Pedestrian Tunnels
- Underground Storage Structures

## MATERIAL SPECIFICATION

### • Chemical Composition

The Raw material shall be tested and the cast analysis values shall conform to below :

**Table 2**

Steel		Coating	
Element	Percentage	Element	Percentage
C	0.15 (max)	Zn	99.88
P	0.05 (max)		
S	0.05 (max)	Al	0.02
Mn	0.6 (max)		
Si	0.35 (max)		

**Table 3 • Mechanical Properties**

Yield Strength	:	230 Mpa (Minimum)
Elongation Gauge Length	:	16% minimum on 200mm
Anti-corrosion coating	:	By hot dip galvanized with a thickness pf 610 gr/cm <sup>2</sup>

## Design Factors

Design begins with reconnaissance and location surveys. The services of experienced soils and drainage engineers provide the best assurance of economical construction and subsequent minimum maintenance.

The following design factors must be considered :

1. Size, shape, alignment, grade and other configuration. These depend on hydrology and hydraulics, and on service requirements.
2. Structural adequacy to meet embankment and superimposed live loads, along with hydraulic forces.
3. Trouble-free service through selection of materials to resist wear and provide durability.
4. Economics – First cost of materials and installation, plus maintenance cost evaluated on the basis of present worth.
5. Influence of climate or season of the year.
6. Ease of repair or replacement in relation to the importance or service of the facility.

### Features

Correct installation procedures will ensure maximum performance. The interaction of a well compacted engineered backfill with the superior section properties of corrugated steel plate ensures a structure capable of supporting high loads with the most economical use of steel.

### Speed

Installation times are measured in weeks rather than in months. This feature means shorter road closure periods and minimum disruption of environmentally sensitive locations such as fish-bearing streams.

### Simplicity

Corrugated steel plate installation is economical, simple and rapid. Because of the increased plate stiffness and improved properties in bending, and less installation sensitive than concrete products.

### Configuration

Three components are used to make up all structures : Curved corrugated Plate, Back filling, and foundation.

### Note

- Some client may have their own design criteria
- Our Sales Engineers and Sales Representatives, with technical support from our engineering department, are trained to work with you on economical solutions to your design challenges

# FACTORS AFFECTING CORRUGATED STEEL PIPE DURABILITY

## Durability in Soil

The durability of metal pipe in soil is a function of several interacting parameters including soil resistivity, acidity (pH), moisture content (aeration). However, all of the corrosion processes involve the flow of current from one location to another (a corrosion cell). Thus the higher the resistivity, the greater the durability. Table on follow is lists typical ranges of resistivity values for the primary soil types.

**Table 4 : Typical soil resistivity**

Classification	Resistivity Ohm-cm
Clay	750-2000
Loam	2000-10000
Gravel	10000-30000
Sand	30000-50000
Rock	50000-infinity*
*Theoretical	

Most soils fall in a PH range of 6 to 8, and that is favorable to durability. Soils with lower pH values (acid soils) tend to be more corrosive. The relative corrosivity of soils of various physical characteristics is describe in table below.

**Table 5 : Corrosiveness of Soils**

Soil Type	Description of Soil	Aeration	Drainage	Color	Water Table
I Mildly Corrosive	1. Sands or sandy loams 2. Light textured silt loams 3. Porous loams or clay loams thoroughly oxidized to great depths	Good	Good	Uniform color	Very Low
II Moderately Corrosive	1. Sandy loams 2. Silt loams 3. Clay loams	Fair	Fair	Slight mottling	Low
III Extremely Corrosive	1. Clay loams 2. Clays	Poor	Poor	Heavy texture moderate mottling	0.5 to 1m below surface
IV Severely Corrosive	1. Muck 2. Peat 3. Tidal marsh 4. Clays and organic soils	Very Poor	Very Poor	Bluish-gray mottling	At surface; or extreme impermeability

## Durability in Water

There is little difference in the durability of steel in still natural waters in the pH range of 4.5 to 9.5, because the corrosion products maintain a pH of 9.5 at the steel surface. Increasing levels of dissolved oxygen and carbon dioxide can accelerate corrosion. The most important effect of carbon dioxide in water relates to its interference with the formation of the protective calcium carbonate scale. Dissolved salts can increase durability by decreasing oxygen solubility and neutralizing acidity.

## Resistance to Abrasion

The potential for metal loss in the invert of a drainage structure due to abrasive flows is often overlooked by designers and its effects are often mistaken for corrosion. Three factors must combine to caused invert abrasion :

- Abrasive Bed load
- Sufficient velocity to carry the bed load
- Flow duration and frequency

## Coating

Galvanized Z610 / EN ISO 1461

Galvanized Z610 / EN ISO 1461 is a hot-dip zing coating that forms a superior barrier over steel. Calcium attracted from naturally hard water can aid in providing additional protection as its develops mineral scale on the pipe surface. As the zing coating corrodes slowly over time, it galvanically protects the base steel as long as any zinc remains.

## Additional Coating

Additional service life can be provided by increasing the thickness of the base or with use Polymer Coating for additional coating. We recommend to using polymer coating because it's environmentally friendly and also has been tested can add life time to 10 years or approval equivalent.

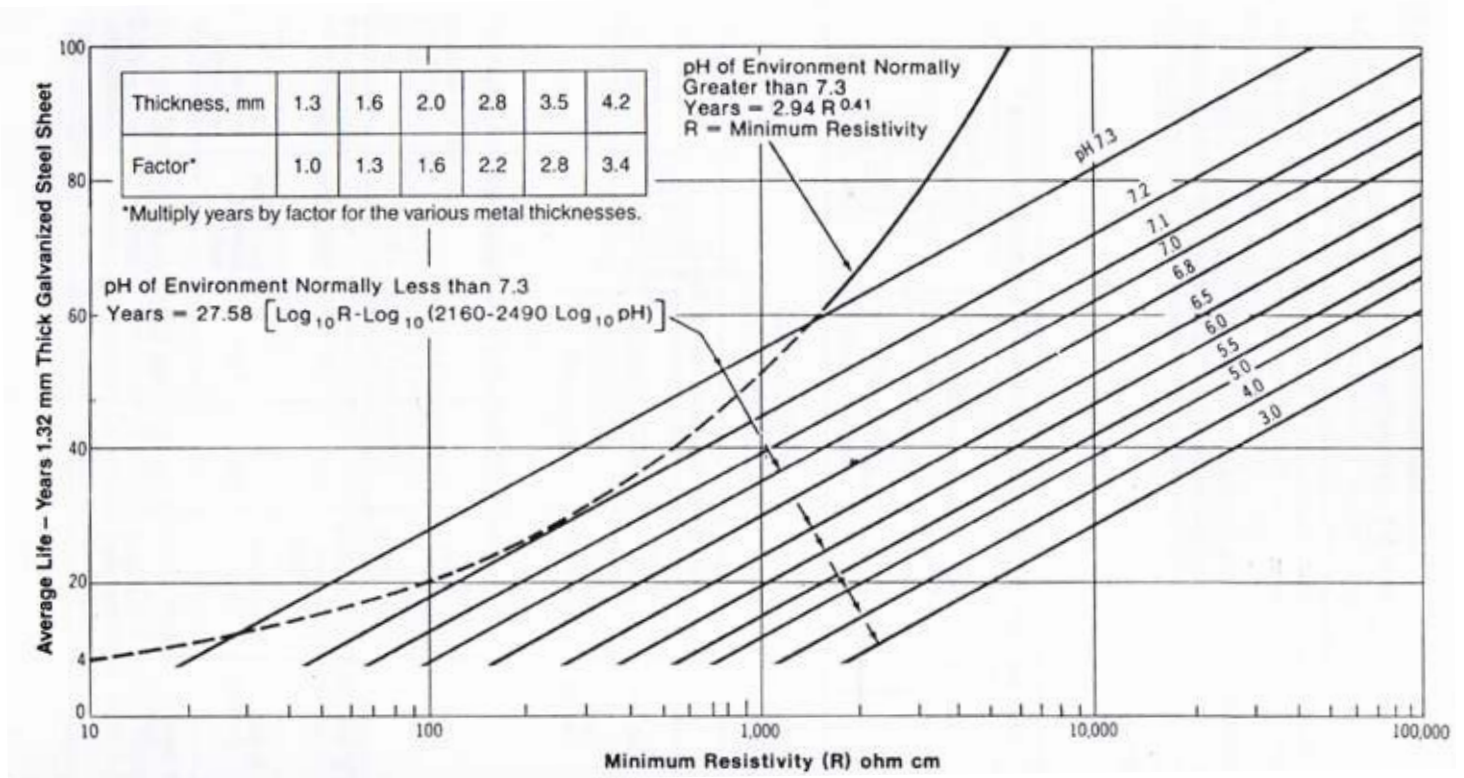

Before designing culverts, storm sewers and other drainage structures, one should consider the design of ditches, gutters, chutes, median swales, and other channels leading to these structures.

### Flow Conditions and definitions

Culvert considered here are circular pipes and pipe-arches with a uniform barrel cross section throughout.

There are two major types of culvert flow conditions

#### • Inlet Control

A culvert flowing in inlet control is characterized by shallow, high velocity flow categorized as supercritical. Inlet control flow occurs when the culvert barrel is capable of conveying more flow than the inlet will accept. The control section is near the inlet and the downstream pipe and flow have no impact on the amount of flow through the pipe. Under inlet control, the factors of primary importance are :

1. The cross-sectional area of the barrel
2. The inlet configuration or geometry
3. The headwater elevation of the amount of ponding upstream of the inlet
4. The barrel slope

#### • Outlet Control

A culvert flowing in outlet control is characterized by relatively deep, lower velocity flow categorized as subcritical. Outlet control flow occurs when the culvert barrel is not capable conveying as much as the inlet opening will accept. The control section is at the outlet of the culvert.

The factors that must be considered for outlet control :

1. The tail-water elevation in the outlet channel
2. The barrel slope
3. The barrel roughness
4. The length of the barrel



### NESTABLE FLANGE E 100

Nestable Flange E-100 is the most common and versatile of the corrugated steel pipe shapes. This shape is used primarily for culverts, small bridge, but is also appropriate for storage bins, storm water drains and sub-drains.

#### Section Properties

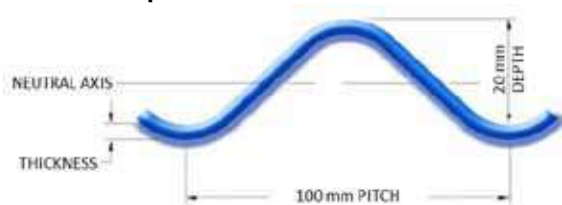

Table 6 : Section Properties of CSP 100mm x 20mm

Thickness (mm)	Tangent Length (mm)	Moment of Inertia (mm <sup>4</sup> /mm)	Area of Section (mm <sup>2</sup> /mm)	Section Modulus (mm <sup>3</sup> /mm)	Radius of Gyration (mm)	Ultimate Seam Strength (KN/m)
2	22.96	96.85	2.188	8.805	6.65	265
2.5	22.52	118.38	2.736	10.523	6.58	380
3	22.07	145.60	3.283	12.66	6.66	475
3.5	21.61	158.46	3.829	13.486	6.43	580

#### Approximate Weight (Kg/m)

Table 7 : Weight (Approximately)

DIAMETER (mm)	Weight / Meter ( Kg )			
	2.0	2.5	3.0	3.5
450	30	38	45.5	49
500	35	44	53	61
600	40	48	60	68
800	49	61	74	89
900	55	69	83	96
1000	60	75	90	101
1200	75	96	113	126
1400	83	104	125	146
1500	92	115	137	159
1600	94	120	141	166
1800	-	136	164	191
2000	-	-	185	219

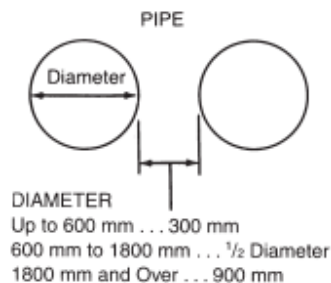

The information in this brochure should be checked in detail by the professional engineer responsible for the design to verify its accuracy; also, the assumption and methods used to obtain the information should be reviewed to make certain they are applicable and suitable for the design.

Note :

1. Minimum cover for High Way is 0.6 m until Top Of Pavement
2. Minimum cover for Rail Way is 1.0 m until Top Of Rail
3. Minimum cover is measured from top of pipe to top of subgrade or top of rigid pavement. Minimum cover for heavy construction equipment or other excessive loading is 1.2m.
4. Minimum clear spacing between structures as indicated in follow figure.



# NESTABLE FLANGE E 100

## Structural Design

The following steps describe a basic, typical procedure for designing a structural Nestable Flange E-100 but are not intended to represent all possible considerations that a prudent designer should investigate. Although not all of these steps will be covered in this document, additional design aids are available. Should the designer have questions regarding an aspect of structures designs.

## Design Sequence and Reference

### 1. General Structure Selection

- Guidelines for selection of Hydraulics, Traffic / pedestrian passage, or grade separation structure

### 2. Additional Selection Consideration

- Refining Structure Selection

### 3. Check Service Life and Protection of Structure from Environment

- Environmental Effects
- Design Life
- Material Selection – Galvanized Steel or Aluminum
- Protection from aggressive environments
- De-icing Salts

### 4. Check Structure Hydraulics (not covered herein)

- Performing Hydraulic Checks
- Hydraulics of corrugated metal structures
- Tools for hydraulic analysis
- Scour Analysis

### 5. Check Structural Design

- Performing Structural Checks
- Design Methods outline
- Material Properties

### 6. Specify Bedding, Backfill and Check Foundation

- Soil envelope under and around structure
- Bedding
- Foundation Requirements
- Backfill envelope – Backfill recommendations

### 7. Structure End Treatment

- Bevels, Skews
- Headwalls
- Toe-walls and cutoff walls

### 8. Specify Structure Installation Procedure

### 9. Material, Design, and Installation Specifications

- AASHTO
- ASTM
- AS
- SNI

### 10. CAD Drawings

Structure Shape and detail drawings are available to the designer upon request.

*These are the typical steps involved in designing a structural **Nestable Flange E-100**. More specific information on each step or topic is available from KBP Engineered Solutions.*

## Design Service

KBP Engineering Department offers an obligation professional design service for the application of Nestable Flange E-100. The service includes but is not limited to: structural design; hydraulic design; construction advice and details; durability advice; assembly drawings and installation guidelines. Structures are custom designed to meet with the required clearance requirements or hydraulic waterway area.

Structural reviewed will used 2 method :

- Module calculation

Based on AASHTO, ASTM, AS, and SNI. Depending on client needed.

- Finite Element Analysis

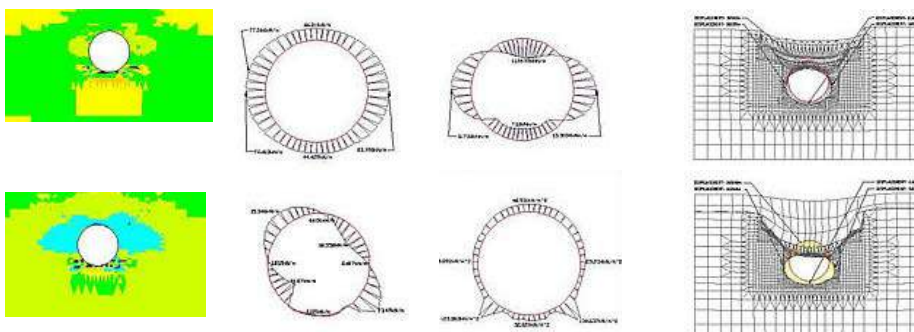



# NESTABLE FLANGE E 100

Nestable Flange E100, due to their strength, light weight and resistance to fracture, can be installed quickly, easily, and with the least expensive equipment.

## Unloading and Handling

Although Nestable will withstand rough handling without deformation, they should be handled with reasonable care. Nestable should never be dumped directly from a truck bed while unloading, but should be lifted or rolled to protect the galvanized surface. Dragging the structures at any time may damage the coatings and jeopardize durability. Also, avoid striking rocks or hard objects when lowering pipe into trenches.

## Assembly

Before starting to assembly the structure, study the site specific General Arrangement Drawing supplied by PT.Karunia Baja Persada paying particular attention to the Details showing the orientation of the plates and the stagger of the joints as these are vitally important. Plates are not symmetrical and must be oriented correctly.

The laying sequence shown on the Plate Layout Detail on the drawing is suggested to minimise the possibility of misalignment of the structures.

For short structures the full length of bottom plates are laid in the first stage and stage two effectively completes the structure if the assembly sequence is followed through.

In the case of longer structures, the methodology of the first two stages shall be repeated for subsequent segments of the structure to ensure that slope and alignment are maintained.

During assembly, connect the bottom and top plates with as few bolts as possible. Insert sufficient bolts to hold the plates in position, but do not over-tighten the nuts. Loose bolting leaves the plates free to move slightly, which eases matching the remaining bolt holes. About three plate rings behind assembly, insert the remaining bolts. Start at the center of the plates, and work towards the corners. When all bolts are inserted, tighten nuts. Nuts should be finally tightened to the torque maximum  $310 \pm 40$  N-m

### COMPONENTS AND GENERAL ASSEMBLY FOR FLANGED NESTABLE CSP

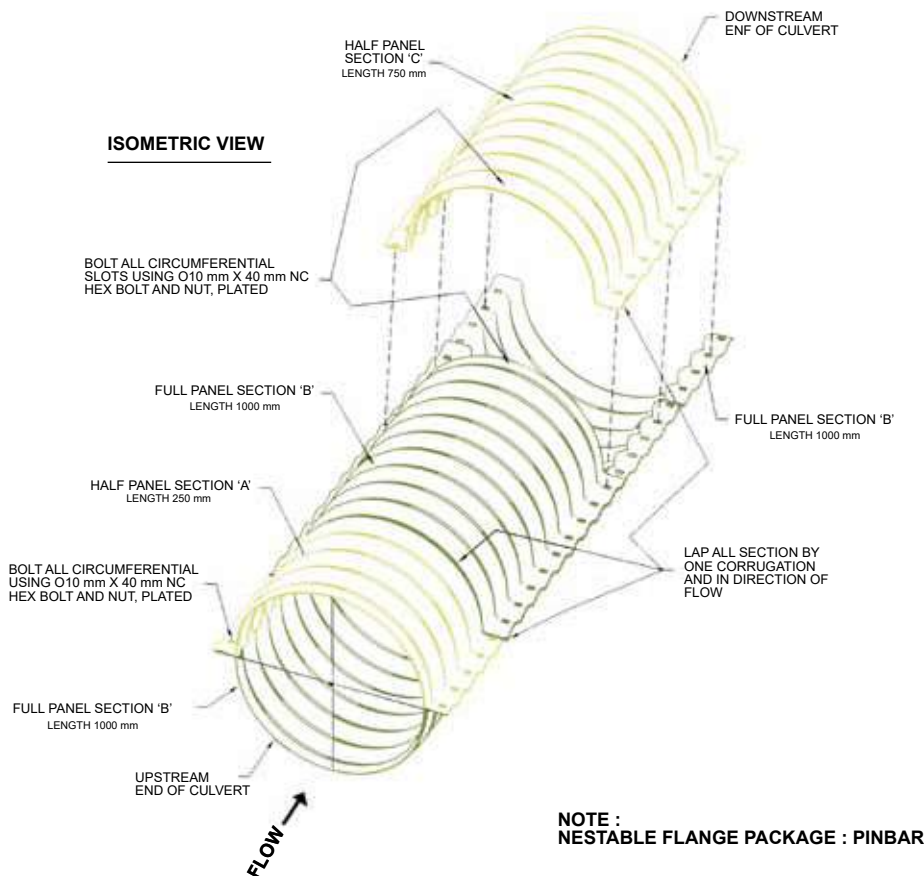

## NESTABLE FLANGE E 100

### Base Preparation

For standard installation it is recommended that the width of the foundation be at least three times the diameter of the NESTABLE and be free of rocks, mud, water, stumps, and organic or frozen material. A properly installed base will facilitate proper alignment and grade of the NESTABLE during installation and the subsequent service life of the application. The bedding blanket is a thin layer of loosely placed granular material (less than 35% fines) that cushions the pipe invert and allows the corrugation to nest or seat into it. A well-graded granular material containing rock fragments as large as 75mm will allow the pipe to settle into the bedding in this fashion. Uniform-graded materials should be limited to angular rock fragments with a nominal size distribution from 20mm to 40mm. See table in below for examples of acceptable material gradations.

### Backfilling

A well-graded granular backfill that is at least 150mm in depth is recommended for the bedding. Poor soil conditions or granular material necessitate a more substantial base under the NESTABLE. The use of a geotextile material is common to provide soil strength and separation. Structural backfill shall be placed in loose lifts not exceeding 200mm and compacted to a minimum 90% standard proctor density. The backfill shall be placed and compacted with care under the haunches of the pipe and shall be raised evenly on both sides of the pipe by working backfill operations from side to side. The side to side backfill differential shall not exceed 600mm or one-third of the rise of the structure, whichever is less (generally not exceeding more than one lift difference). Structural backfill shall continue to not less than 300mm above the top of pipe. Backfill material used for the remainder of the burial shall be as defined in the project specifications or as directed by the engineer.

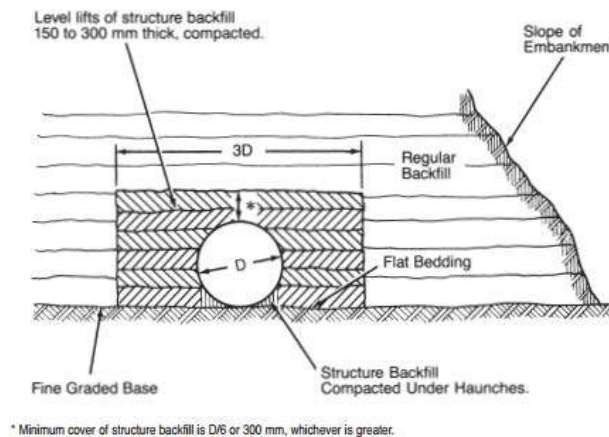

**Table 8 : Example of Acceptable Bedding and Backfill Gradations for Nestable Flange E\_100**

Sieve Size	A % Passing	B % Passing	C % Passing	D % Passing	E % Passing	F % Passing	G % Passing	H % Passing
60	-	-	-	-	-	-	-	100
50	100	-	-	-	-	-	-	-
40	-	100	100	-	-	-	-	-
25	70 to 100	-	95 to 100	100	-	-	-	70 to 100
20	50 to 90	80 to 100	-	90 to 100	-	-	100	-
12	-	-	25 to 60	-	-	-	-	-
10	-	60 to 90	-	20 to 55	100	100	80 to 100	-
No. 4	30 to 60	30 to 90	0 to 10	0 to 10	90 to 100	95 to 100	60 to 100	25 to 100
No. 8	-	-	0 to 5	0 to 5	65 to 100	70 to 100	45 to 95	-
No. 16	-	-	-	-	40 to 85	38 to 80	-	-
No. 30	9 to 33	3 to 20	-	-	20 to 60	18 to 60	-	-
No. 40	-	-	-	-	-	-	-	10 to 50
No. 50	-	-	-	-	7 to 40	5 to 30	7 to 55	-
No. 100	-	-	-	-	0 to 20	0 to 10	-	-
No. 200	0 to 20	0 to 20	-	-	0 to 10	0 to 5	0 to 15	5 to 15

Material Passing No. 40 sieve : max Liquid Limit = 25, Max Plasticity Index =6



# MULTI-PLATE

## Section Properties

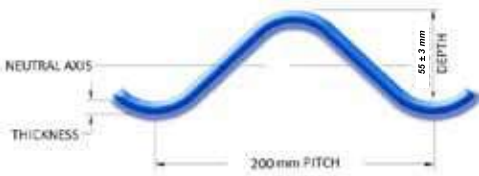

NOTE :  
MULTI PLATE PACKAGE : WRENCH, HAND HOOK, AND PINBAR

**Table 9 Section Properties of CSP 200 mm x 55 ± 3 mm**

Thickness (mm)	A (°)	Tangent Length (mm)	Moment of Inertia (mm <sup>4</sup> /mm)	Area of Section (mm <sup>2</sup> /mm)	Section Modulus (mm <sup>3</sup> /mm)	Radius of Gyration (mm)	Ultimate Seam Strength (KN/m)
3.0	45.20	32.20	1330	46	19.50	3.50	650
3.5	45.50	31.30	1580	53	19.50	4.15	815
4.0	45.70	30.40	1800	60	19.60	4.70	930
5.0	46.30	28.40	2300	74	19.60	5.90	1180
6.0	47.00	26.50	2750	88	19.70	7.10	1430
7.0	47.70	24.70	3200	103	19.70	8.30	1630

## 1. MULTI-PLATE PIPE

This shape is used for culverts, storm sewers, aggregate tunnels, vehicular and pedestrian tunnels and stream enclosures. Function well in all applications, but especially in those with high cover.

## Section Properties

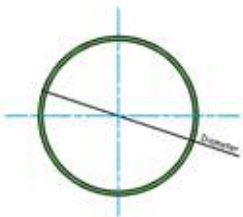

**Table 10: Section Properties of Multi-plate Pipe**

Structure Number	Diameter (mm)	Periphery (m)	End Area (m <sup>2</sup> )	Weight Per Meter (Kg)					
				3 mm	3,5 mm	4 mm	5 mm	6 mm	7 mm
20M	1500	4.7	1.8	168	194	219	272	323	375
24M	1800	5.6	2.5	196	226	257	318	378	439
28M	2100	6.6	3.4	231	267	302	374	445	517
30M	2250	7.1	4.0	245	283	321	398	471	549
32M	2400	7.5	4.5	266	307	347	431	512	594
36M	2700	8.5	5.7	294	339	385	477	567	659
40M	3000	9.4	7.0	329	380	430	533	634	736
42M	3150	9.9	7.8	343	396	449	557	662	769
44M	3300	10.3	8.5	364	420	475	590	701	814
48M	3600	11.3	10.1	392	452	513	636	757	878
52M	3900	12.2	11.9	427	493	558	692	823	956
54M	4050	12.7	12.8	441	509	577	716	851	988
56M	4200	13.2	13.8	462	533	604	749	890	1034
60M	4500	14.1	15.8	490	565	641	795	946	1098
64M	4800	15.0	18.0	525	606	686	851	1008	1176
66M	4950	15.5	19.1	539	622	705	874	1040	1208
68M	5100	16.0	20.3	560	646	732	908	1079	1253
72M	5400	16.9	22.8	588	678	769	954	1135	1318
76M	5700	17.9	25.4	-	719	814	1010	1201	1395
78M	5850	18.3	26.7	-	735	833	1033	1229	1427
80M	6000	18.8	28.1	-	759	860	1066	1268	1473
84M	6300	19.7	31.0	-	-	897	1113	1324	1537
88M	6600	20.7	34.0	-	-	-	1169	1390	1615
90M	6750	21.2	35.6	-	-	-	1192	1418	1647
92M	6900	21.6	37.2	-	-	-	1225	1457	1692
96M	7200	22.6	40.5	-	-	-	1272	1513	1757
100M	7500	23.5	43.9	-	-	-	-	1579	1834
102M	7650	24.0	45.7	-	-	-	-	1607	1866
104M	7800	24.4	47.5	-	-	-	-	1646	1911
108M	8100	25.4	51.3	-	-	-	-	-	1976
112M	8400	26.3	55.1	-	-	-	-	-	2054
114M	8550	26.8	57.1	-	-	-	-	-	2086

## 2. MULTI-PLATE PIPE ARCHES

Limited headroom. Has hydraulic advantages at low flow levels. Culverts, storm sewer, underpass and stream enclosures.

### Section Properties

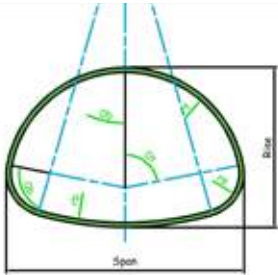

Table 11 : Section Properties of Multi-plate Pipe-Arches

Structure Number	Span (mm)	Rise (mm)	Periphery (m)	End Area (m <sup>2</sup> )	Side Radius rs (mm)	Top Radius rt (mm)	Bottom Radius rb (mm)	Side Angle Øs (deg)	Top Angle Øt (deg)	Bottom Angle Øb (deg)	Weight Per Meter (Kg)					
											3 mm	3,5 mm	4 mm	5 mm	6 mm	7 mm
11 MA 4-4	1850	1550	5.4	2.10	633	932	1724	85	79	16	195	224	254	315	374	434
12 MA 4-7	2280	1730	6.3	1.90	633	1181	1768	85	68	27	223	258	292	362	430	500
18 MA 4-7	2540	1880	7.0	3.60	633	1280	2912	85	79	16	251	290	328	407	483	561
18 MA 4-8	2890	2070	8.0	4.50	633	1448	4756	85	84	11	285	329	372	461	548	637
18 MA 4-11	3280	2200	8.7	5.30	633	1692	3158	85	72	23	307	354	401	497	591	686
20 MA 4-11	3430	2300	9.2	5.90	633	1740	4195	85	77	18	328	378	428	530	630	732
22 MA 4-12	3700	2440	9.9	6.80	633	1873	5057	85	79	16	349	402	456	565	672	780
22 MA 4-15	4100	2570	10.6	7.80	633	2157	3827	85	69	26	377	435	492	610	725	841
26 MA 4-15	4390	2770	11.5	9.10	633	2224	6174	85	79	16	412	474	537	666	792	919
27 MA 5-15	4580	3050	12.2	10.90	800	2323	5705	84	78	18	433	500	566	702	834	969
32 MA 5-15	4890	3300	13.4	13.00	800	2446	12623	84	88	8	475	548	620	770	915	1062
30 MA 5-17	5070	3280	13.4	13.00	800	2570	6650	84	79	17	470	540	612	760	905	1050
32 MA 5-18	5340	3430	14.1	14.30	800	2697	7600	84	80	16	496	572	648	804	957	1111
32 MA 5-20	5620	3510	14.6	15.20	800	2883	6380	84	75	21	-	596	675	838	996	1156
37 MA 5-20	5930	3770	15.7	17.70	800	2980	11000	84	84	12	-	644	730	905	1076	1250
39 MA 5-22	6350	3950	16.7	19.70	800	3195	10840	84	82	14	-	-	767	951	1131	1314

## 3. MULTI-PLATE ARCHES

Low clearance, large waterway opening. Aesthetic shapes and open natural bottoms for environmentally-friendly crossings.

### Section Properties

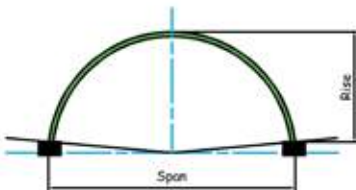

Table 12: Section Properties of Multi-plate Arches

Structure Number	Span (mm)	Rise (mm)	Periphery (m)	End Area (m <sup>2</sup> )	Radius (mm)	Weight Per Meter (Kg)					
						3.0 mm	3.5 mm	4.0 mm	5.0 mm	6.0 mm	7.0 mm
12MA	2000	890	2.9	1.30	1006	108	123	139	169	199	229
15MA	2500	1100	3.6	2.01	1259	136	156	175	214	252	291
18MA	3000	1310	4.4	2.88	1513	157	180	203	249	294	339
22MA	3500	1640	5.3	4.31	1753	192	220	248	305	361	417
23MA	4000	1590	5.5	4.61	2051	199	228	257	316	374	433
26MB	4000	1970	6.2	6.02	2000	227	260	293	361	427	494
26MA	4500	1800	6.2	5.88	2305	227	260	293	361	427	494
29MB	4500	2180	6.9	7.48	2251	248	285	321	396	469	543
29MA	5000	2010	6.9	7.32	2559	248	285	321	396	469	543
33MB	5000	2510	7.9	9.68	2500	283	325	367	452	536	620
32MA	5500	2220	7.6	8.91	2813	276	317	357	441	522	604
36MB	5500	2720	8.6	11.50	2750	304	349	395	487	577	669
35MA	6000	2430	8.3	10.66	3067		341	385	475	563	652
39MB	6000	2930	9.3	13.48	3000		381	431	532	630	730
37MA	6500	2500	8.8	11.77	3363			412	508	603	698
42MB	6500	3140	10.0	15.63	3251			459	566	672	778
40MA	7000	2700	9.5	13.76	3616				543	644	746
46MB	7000	3470	10.9	18.74	3500				623	739	856
43MA	7500	2910	10.2	15.93	3870					697	807
49MB	7500	3670	11.6	21.25	3750					792	917
46MA	8000	3120	10.9	18.23	4123					739	856
52MB	8000	3880	12.3	23.91	4001					833	966
49MA	8500	3330	11.6	20.69	4377						917
56MB	8500	4210	13.3	27.74	4250						1043



**Table 13: Section Properties of Multi-plate Arch Type AB**

Structure Number	Span (mm)	Rise (mm)	Periphery (m)	End Area (m <sup>2</sup> )	Internal Radius rt (mm)	Bottom Angle $\theta_b$ (deg)	Top Step (mm)	Bottom Step (mm)
26AB	4000	1928	6.230	6	2.08	2.08	500	295
29AB	4500	2138	6.935	7.45	2.94	2.94	563	295
33AB	5000	2465	7.875	9.64	0.79	0.79	625	295
36AB	5500	2675	8.580	11.47	1.58	1.58	688	295
39AB	6000	2885	9.285	13.45	2.24	2.24	751	295
42AB	6500	3094	9.990	15.59	2.83	2.83	814	295
46AB	7000	3420	10.930	18.69	1.32	1.32	875	295
49AB	7500	3630	11.635	21.2	1.87	1.87	938	295
52AB	8000	3839	12.340	23.86	2.34	2.34	1001	295
56AB	8500	4167	13.280	27.67	1.13	1.13	1063	295

#### 4. MULTI-PLATE UNDERPASS

Offers efficient shape for passage of pedestrians or livestock, vehicular traffic and bicycles with minimal buried invert.

#### Section Properties

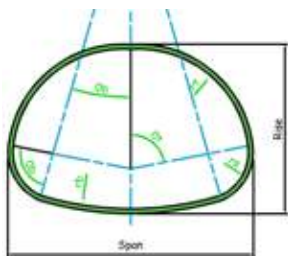

**Table 14: Section Properties of Multi-plate Underpass**

Structure Number	Span (mm)	Rise (mm)	Periphery (m)	End Area (m <sup>2</sup> )	Side Radius rs (mm)	Top Radius rt (mm)	Bottom Radius rb (mm)	Side Angle $\theta_s$ (deg)	Top Angle $\theta_t$ (deg)	Bottom Angle $\theta_b$ (deg)	Weight Per Meter (Kg)					
											3 mm	3,5 mm	4 mm	5 mm	6 mm	7 mm
25 M 4-8	3220	2780	9.6	7.00	897	1609	3481	60	105	15	350	403	456	562	671	780
27 M 4-11	3690	3060	10.8	8.70	897	1843	3458	60	99	21	384	443	502	623	740	860
29 M 4-11	3830	3180	11.3	9.50	897	1913	4116	60	102	18	400	460	520	646	776	891
31 M 4-12	4080	3350	12.0	10.70	897	2039	4571	60	102	18	427	493	560	691	821	953
33 M 4-12	4220	3480	12.4	11.60	897	2108	5520	60	105	15	441	508	575	714	848	985
34 M 4-15	4630	3690	13.4	13.30	897	2314	4786	60	99	21	476	548	621	770	915	1062
37 M 4-15	4830	3880	14.1	14.80	897	2414	5997	60	103	17	504	581	659	815	968	1124
39 M 4-15	4960	4000	14.6	15.80	897	2481	7105	60	106	14	518	597	676	834	996	1156
39 M 4-18	5320	4150	15.3	17.30	897	2659	5699	60	99	21	539	621	703	868	1032	1204
41 M 4-19	5570	4320	16.0	18.90	897	2784	6123	60	99	21	565	653	740	917	1089	1266
43 M 4-20	5820	4500	16.7	20.60	897	2910	6558	60	99	21	-	686	776	963	1144	1328
46 M 4-20	6010	4680	17.4	22.40	897	3005	7935	60	103	17	-	710	804	997	1185	1376

## Section Properties

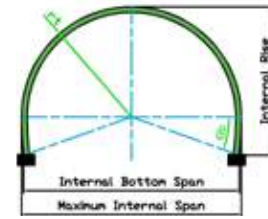

## 5. MULTI-PLATE HORSESHOE ARCH TYPE HA

Railroad underpasses or large clearance areas.

Table 15: Section Properties of Multi-plate Horseshoe Arch Type HA

Structur Number	Max Span (mm)	Bottom Span (mm)	Rise (mm)	Periphery (mm)	End Area (m <sup>2</sup> )	Radius r (mm)	Bottom Angle $\Theta_b$ (deg)	Top Step (mm)	Bottom Step (mm)
HA 22	2400	2006	1859	5290	3.76	12003	3.31	6002	47
HA 27	3000	2568	2276	6465	5.75	15003	1.13	7502	53
HA 32	3500	2934	2704	7640	7.98	17503	3.03	8752	47
HA 36	3950	3326	3041	8580	10.12	19753	2.65	9882	48
HA 40	4400	3717	3377	9520	12.52	22003	2.35	11002	49
HA 44	4900	4206	3707	10460	15.31	24503	0.88	12252	53
HA 49	5450	4670	4130	11635	18.97	27253	1.03	13632	53
HA 54	6000	5135	4552	12810	23.02	30003	1.16	15002	53
HA 59	6550	5599	4974	13985	27.46	32753	1.26	16382	52
HA 64	7100	6066	5395	15160	32.28	35503	1.31	17752	52
HA 70	7800	6710	5896	16570	38.75	39003	0.79	19502	53
HA 76	8500	7335	6397	17980	45.82	42503	0.35	21252	55

## Section Properties

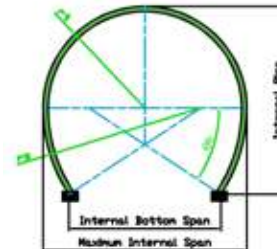

## 6. MULTI-PLATE HORSESHOE ARCH TYPE EA

Railroad underpasses or large clearance areas and Higher Rise.

Table 16: Section Properties of Multi-plate Horseshoe Arch Type EA

Structure Number	Max Span (mm)	Bottom Span (mm)	Rise (mm)	Periphery (mm)	End Area (m <sup>2</sup> )	Top Radius $r_t$ (mm)	Side Radius $r_s$ (mm)	Bottom Angle $\Theta_b$ (deg)	Top Step (mm)	Bottom Step (mm)
16 EA 5	2336	1923	2370	6230	4.79	1168	3600	19.5	584	278
20 EA 5	2934	2521	2669	7170	6.74	1467	3600	19.5	734	278
22 EA 6	3233	2805	3057	8110	8.56	1617	4950	16.92	808	282
24 EA 7	3533	2902	3421	9050	10.40	1766	4500	21.57	883	274
25 EA 10	3682	2932	4202	10695	13.43	1841	7620	18.05	921	281
28 EA 10	4131	3229	4407	11400	15.68	2066	6300	21.82	1033	274
31 EA 11	4580	3675	4872	12575	19.29	2290	7600	19.86	1145	277
36 EA 11	5328	4313	5231	13750	23.97	2664	6750	22.36	1332	273
40 EA 12	5926	1856	5765	15160	29.41	2963	7600	21.63	1482	274
44 EA 14	6525	5083	6493	17040	36.28	3262	7600	25.16	1631	267
48 EA 15	7121	5474	7002	18450	42.57	3561	7600	26.92	1780	263
52 EA 17	7720	5623	7711	20330	50.52	3860	7600	30.45	1930	254
57 EA 18	8468	6128	8285	21975	59.41	4234	7600	32.21	2117	250



## 7. MULTI-PLATE HORIZONTAL ELLIPSE

### Section Properties

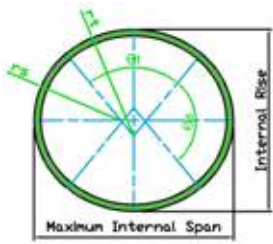
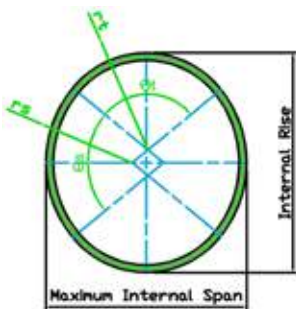

**Table 17: Section Properties of Multi-plate Horizontal Ellipse**

Structure Number	Max Span (mm)	Rise (mm)	Periphery (mm)	End Area (m2)	Top Radius $r_t$ (mm)	Side Radius $r_s$ (mm)	Top Angle $\theta_t$ (deg)	Side Angle $\theta_s$ (deg)	Top Step (mm)	Bottom Step (mm)
6 HE 6	1826	1643	5640	2.36	955	770	78.89	101.11	227	227
7 HE 7	2138	1928	6580	3.24	1163	905	79.07	100.93	266	266
10 HE 5	2306	2079	7050	3.74	1206	920	109.02	70.98	506	506
10 HE 6	2457	2223	7520	4.27	1293	1005	101.85	78.15	478	478
12 HE 6	2777	2508	8460	5.43	1452	1110	109.1	70.9	610	610
14 HE 6	3095	2796	9400	6.73	1609	1215	115.08	64.92	745	745
14 HE 7	3250	2935	9870	7.44	1699	1300	109.09	70.91	713	713
16 HE 6	3411	3085	10340	8.18	1765	1319	120.08	59.92	884	884
18 HE 6	3731	3371	11280	9.76	1925	1415	124.03	55.97	1022	1022
19 HE 7	4043	3656	12220	11.48	2091	1560	120.67	59.33	1056	1056
20 HE 7	4200	3801	12690	12.40	2169	1611	122.52	57.48	1126	1126
21 HE 7	4362	3942	13160	13.35	2251	1655	124.02	55.98	1195	1195
12 HE 18	4634	4188	14100	15.35	2614	2010	61.13	118.87	363	363
14 HE 18	4950	4478	15040	17.50	2743	2135	68	112	469	469
14 HE 19	5017	4615	15510	18.62	2850	2205	65.48	114.52	453	453
14 HE 20	5264	4752	15980	19.78	2957	2275	63.13	116.87	438	438
18 HE 18	5587	5051	16920	22.20	3032	2375	79.18	100.82	695	695
20 HE 18	5902	5338	17860	24.75	3178	2493	83.94	96.06	815	815
21 HE 18	6065	5478	18330	26.08	3258	2548	86	94	875	875
21 HE 19	6219	5618	18800	27.45	3353	2623	83.58	96.42	853	853
21 HE 20	6525	5901	19740	30.30	3540	2775	79.2	100.8	812	812
24 HE 20	6849	6191	20680	33.28	3671	2875	87.31	92.69	1015	1015
24 HE 21	7005	6330	21150	34.82	3797	2950	85.11	94.89	992	992
28 HE 18	7176	6486	21620	36.40	3791	2950	98.67	81.33	1321	1321
27 HE 21	7479	6760	22560	39.64	3992	3124	90.37	89.63	1178	1178
30 HE 20	7801	7052	23500	43.05	4128	3218	97.12	82.88	1396	1396
30 HE 21	7953	7194	23970	44.80	4218	3298	95.07	84.93	1370	1370
31 HE 21	8112	7338	24440	46.59	4295	3355	96.49	83.51	1435	1435
33 HE 21	8432	7623	25380	50.27	4452	3465	99.11	80.89	1654	1654
35 HE 21	8751	7910	26320	54.09	4608	3575	101.59	78.41	1695	1695

## 8. MULTI-PLATE VERTICAL ELLIPSE

### Section Properties



**Table 18: Section Properties of Multi-plate Vertical Ellipse**

Structure Number	Max Span (mm)	Rise (mm)	Periphery (mm)	End Area (m2)	Top Radius $r_t$ (mm)	Side Radius $r_s$ (mm)	Top Angle $\theta_t$ (deg)	Side Angle $\theta_s$ (deg)	Top Step (mm)	Bottom Step (mm)
6 VE 6	1643	1826	5640	2.36	770	995	101.11	78.89	424	424
7 VE 7	1928	2138	6580	3.24	905	1163	100.91	79.09	493	493
5 VE 10	2080	2305	7050	3.74	920	1206	70.94	109.06	403	403
6 VE 10	2223	2457	7520	4.27	1005	1293	78.13	101.87	448	448
6 VE 12	2507	2778	8460	5.43	1110	1452	70.93	109.07	485	485
6 VE 14	2795	3095	9400	6.73	1215	1609	64.94	115.06	523	523
7 VE 14	2935	3250	9870	7.44	1300	1699	70.92	109.08	566	566
6 VE 16	3085	3411	10340	8.18	1320	1765	59.89	120.11	561	561
6 VE 18	3371	3730	11280	9.76	1415	1925	55.95	124.05	616	616
7 VE 19	3656	4043	12220	11.48	1560	2091	59.32	120.68	666	666
7 VE 20	3801	4201	12690	12.40	1610	2169	57.51	122.49	689	689
7 VE 21	3942	4362	13160	13.35	1655	2251	55.97	124.03	720	720
18 VE 12	4188	4634	14100	15.35	2010	2614	118.86	61.14	1295	1295
18 VE 14	4478	4950	15040	17.50	2135	2743	112	68	1281	1281
19 VE 14	4615	5107	15510	18.62	2205	2850	114.51	65.49	1361	1361
20 VE 14	4752	5264	15980	19.78	2275	2957	116.88	63.12	1441	1441
18 VE 18	5051	5587	16920	22.20	2375	3032	100.82	79.18	1280	1280
18 VE 20	5341	5903	17860	24.77	24950	3178	96.02	83.98	1283	1283
18 VE 21	5481	6066	18330	26.10	2550	3258	93.97	86.03	1293	1293
19 VE 21	5621	6220	18800	27.47	2625	3353	96.39	83.61	1360	1360
21 VE 21	5901	6526	19740	30.30	2775	3540	100.8	79.2	1494	1494
20 VE 24	6190	6850	20680	33.28	2875	3672	92.7	87.3	1440	1440
21 VE 24	6330	7005	21150	34.82	2950	3767	94.88	85.12	1507	1507
18 VE 28	6486	7176	21620	36.40	2950	3791	81.33	98.67	1350	1350
21 VE 27	6762	7481	22560	39.67	3125	3992	89.62	90.38	1523	1523
20 VE 30	7055	7802	23500	43.07	3220	4128	82.86	97.14	1487	1487
21 VE 30	7197	7955	23970	44.83	3300	4218	84.91	95.09	1543	1543
21 VE 31	7339	8115	24440	46.61	3355	4297	83.53	96.47	1555	1555
21 VE 33	7625	8435	25380	50.30	3465	4454	80.9	99.1	1581	1581
21 VE 35	7911	8754	26320	54.12	3575	4610	78.43	101.57	1607	1607
21 VE 36	8055	8913	26790	56.08	3630	4688	77.26	102.74	1621	1621



## MULTI-PLATE SUPER SPAN

### 1. MULTI-PLATE SUPER SPAN HORIZONTAL ELLIPSE

Larger culverts and bridges. Low headroom, wide-centered flow, good choice when poor foundations are encountered.

#### Section Properties

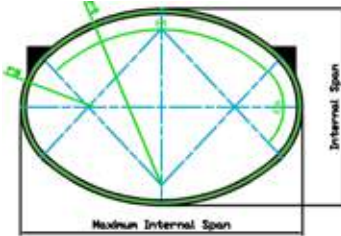

Table 19: Section Properties of Multi-Plate Super Span Horizontal Ellipse

Structure Number	Span (mm)	Rise (mm)	Periphery (m)	End Area (m <sup>2</sup> )	Top & Bottom Radius rt & rb (mm)	Side Radius rs (mm)	Top & Bottom Step (mm)
12 E 6	3110	2120	8.46	5.2	1990	778	470
15 E 6	3760	2360	9.87	6.9	2495	778	580
18 E 8	4600	3010	12.22	10.8	3000	1047	700
20 E 8	5040	3170	13.16	12.3	3336	1047	780
22 E 11	5760	3940	15.51	17.7	3673	1451	860
24 E 11	6190	4100	16.45	19.7	4009	1451	940
26 E 12	6720	4460	17.86	23.3	4346	1586	1020
28 E 12	7150	4620	18.80	25.6	4683	1586	1100
30 E 15	7870	5400	21.15	33.1	5019	1990	1170
32 E 15	8310	5550	22.09	35.8	5356	1990	1250
34 E 15	8740	5710	23.03	38.7	5692	1990	1330
36 E 15	9170	5870	23.97	41.6	6029	1990	1410
38 E 18	9890	6650	26.32	51.1	6366	2394	1490
39 E 18	10110	6720	26.79	52.8	6534	2394	1530
40 E 18	10330	6800	27.26	54.5	6702	2394	1570
41 E 19	10640	7090	28.20	58.5	6871	2528	1610
42 E 19	10860	7170	28.67	60.3	7039	2528	1650
43 E 19	11070	7250	29.14	62.2	7207	2528	1690
44 E 20	11380	7530	30.08	66.5	7375	2663	1730
45 E 21	11700	7820	31.02	71	7544	2798	1760
45 E 24	11990	8430	32.43	78.8	7544	3201	1760
45 E 28	12370	8260	31.31	89.7	7544	3740	1760



## 2. MULTI-PLATE SUPER SPAN HIGH PROFILE ARCH

Culverts, storm sewers, bridges, Higher rise, large area opening. Open natural bottoms for environmentally friendly crossings.

### Section Properties

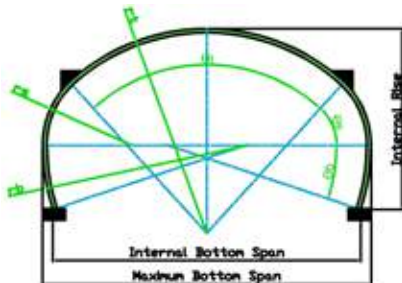

**Table 20: Section Properties of Multi-plate Super Span High Profile Arch**

Structure Number	Max Span (mm)	Bottom Span (mm)	Rise (mm)	Periphery (m)	End Area (m <sup>2</sup> )	Top & Bottom Radius $r_t$ & $r_b$ (mm)	Side Radius $r_s$ (mm)	Angle Below (deg)	Top Step (mm)
24 A 6 - 5	6290	5920	3360	10.810	18.10	4009	1586	17.518	940
25 A 6 - 6	6500	6000	3620	11.515	20.30	4178	1586	20.017	980
26 A 6 - 6	6720	6230	3660	11.750	21.10	4346	1586	19.247	1020
27 A 6 - 6	6940	6470	3710	11.985	22.00	4514	1586	18.534	1060
28 A 6 - 6	7150	6700	3750	12.220	23.00	4683	1586	17.872	1100
30 A 6 - 6	7590	7160	3830	12.690	24.80	5019	1586	16.681	1170
31 A 6 - 6	7800	7390	3870	12.925	25.80	5187	1586	16.143	1210
32 A 6 - 6	8020	7620	3910	13.160	26.70	5356	1586	15.638	1250
33 A 6 - 6	8230	7850	3950	13.395	27.70	5524	1586	15.164	1290
34 A 9 - 8	9030	8380	5060	15.980	39.10	5692	2394	19.424	1330
35 A 9 - 8	9240	8610	5100	16.215	40.30	5861	2394	18.869	1370
36 A 9 - 9	9460	8690	5360	16.920	43.50	6029	2394	20.567	1410
37 A 9 - 8	9680	9080	5180	16.685	42.80	6197	2394	17.849	1450
37 A 9 - 10	9680	8760	5620	17.625	46.80	6197	2394	22.174	1450
38 A 9 - 11	9890	8820	5880	18.330	50.10	6366	2394	23.695	1490
39 A 9 - 12	10110	8870	6140	19.035	53.50	6534	2394	25.139	1530
40 A 9 - 12	10330	8120	6180	19.270	55.00	6702	2394	24.511	1570
41 A 10 - 12	10740	9560	6430	19.975	59.40	6871	2663	23.913	1610
42 A 10 - 12	10950	9800	6480	20.210	61.00	7039	2663	23.343	1650
43 A 10 - 10	11170	10380	6050	19.050	58.10	7207	2663	19.08	1690
44 A 10 - 15	11380	9690	7200	22.090	70.60	7375	2663	27.737	1730
45 A 10 - 15	11600	9640	7240	22.325	72.40	7544	2663	27.121	1760

### 3. MULTI-PLATE SUPER SPAN LOW PROFILE ARCH

Culvert, storm sewers, low headroom and large opening. Bridge structures, stream enclosures. Aesthetic shapes and open natural bottoms for environmentally friendly crossings.

#### Section Properties

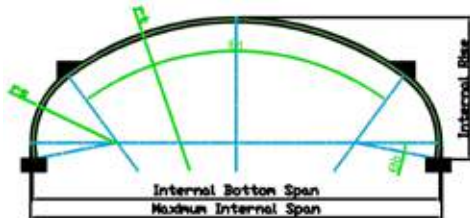

Table 21: Section Properties of Multi-plate Super Span Low Profile Arch

Structure Number	Max Span (mm)	Bottom Span (mm)	Rise (mm)	Periphery (m)	End Area (m <sup>2</sup> )	Top & Bottom Radius $r_t$ & $r_b$ (mm)	Side Radius $r_s$ (mm)	Angle Below (deg)	Top Step (mm)
27 A 8	7080	7020	2770	10.105	15.90	4514	1792	11	1060
28 A 8	7300	7230	2810	10.340	16.60	4683	1792	11	1100
29 A 8	7520	7450	2850	10.575	17.30	4851	1792	11	1130
30 A 8	7730	7670	2890	10.810	18.00	5019	1792	11	1170
31 A 8	7950	7880	2930	11.045	18.70	5187	1792	11	1210
32 A 8	8170	8100	2970	11.280	19.50	5356	1792	11	1250
33 A 8	8380	8320	3010	11.515	20.20	5524	1792	11	1290
34 A 11	9070	8980	3680	13.160	27.00	5692	2454	11	1330
35 A 11	9290	9200	3720	13.395	28.00	5861	2454	11	1370
36 A 11	9500	9410	3760	13.630	28.90	6029	2454	11	1410
37 A 11	9720	9630	3800	13.865	29.80	6197	2454	11	1450
38 A 11	9940	9850	3840	14.100	30.80	6366	2454	11	1490
39 A 11	10150	10060	3880	14.335	31.70	6534	2454	11	1530
40 A 11	10370	10280	3920	14.570	32.70	6702	2454	11	1570
41 A 12	10740	10640	4170	15.275	36.10	6871	2675	11	1610
42 A 12	10960	10860	4210	15.510	37.10	7039	2675	11	1650
43 A 12	11180	11080	4250	15.745	38.20	7207	2675	11	1690
44 A 12	11390	11290	4290	15.980	39.20	7375	2675	11	1730
45 A 12	11610	11510	4320	16.215	40.30	7544	2675	11	1760



#### 4. MULTI-PLATE SUPER SPAN PEAR ARCH

Railroad underpasses or large clearance areas.

##### Section Properties

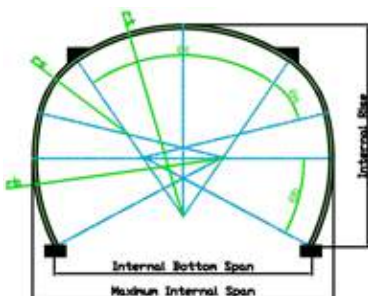

Table 22: Section Properties of Multi-plate Super Span Pear Arch

Structure Number	Max Span (mm)	Bottom Span (mm)	Rise (mm)	Periphery (mm)	End Area (m2)	Top Radius $r_t$ (mm)	Side Radius $r_s$ (mm)	Bottom Radius $r_b$ (mm)	Top Angle $\theta_t$ (deg)	Side Angle $\theta_s$ (deg)	Bottom Angle Bellow Hor. $\theta_b$ (deg)	Top Step (mm)	Bottom Step (mm)
20 AP 5-14	6314	5399	4791	13750	26.88	3900	1900	3900	68.54	34.9	28.02	677	260
23 AP 6-15	7080	5995	5352	15395	33.69	4350	2175	4350	70.72	36.65	28.92	802	258
29 AP 7-15	8101	6748	5859	17275	43.63	5225	2150	5225	74.3	43.23	29.47	1061	257
31 AP 7-18	8908	7529	6536	19155	53.79	5900	2250	5900	70.39	41.34	27.98	1079	261
34 AP 7-20	9651	8149	7141	20800	62.94	6200	2450	6200	73.47	37.99	28.49	1231	259
37 AP 10-20	10663	8768	7753	22915	76.98	7200	2800	7200	68.9	47.56	29.72	1263	256
43 AP 10-21	11598	9321	8358	24795	89.93	7550	2900	7550	76.37	45.94	31.88	1616	251
45 AP 10-24	12238	9822	9157	26675	101.33	7620	3300	7620	79.19	40.42	32.7	1748	248

#### 5. MULTI-PLATE SUPER SPAN PEAR SHAPES

Railroad underpasses or large clearance areas.

##### Section Properties

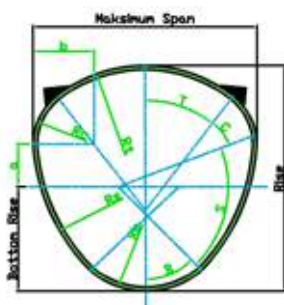

Table 23: Section Properties of Multi-plate Super Span Pear Arch

Structure Number	Max Span (mm)	Rise (mm)	Rise Bottom (mm)	Bottom Radius (mm)	B (deg)	Side Radius (mm)	S (deg)	Corner Radius (mm)	C (deg)	Top Radius (mm)	T (deg)	a (mm)	b (mm)	End Area (m2)
75 M 15-72-45	7210	7820	4530	27203	8.12	50506	6.30	19103	7.25	44703	8.25	760	1990	18.10
81 M 15-75-54	7570	8430	5110	28204	4.12	59905	7.54	17503	9.14	48503	9.40	890	1710	20.30
90 M 18-78-46	8360	8230	5510	28203	7.56	62005	2.40	14005	9.18	60703	4.24	530	1420	21.10
84 M 15-97-36	8100	8610	5460	24403	4.2	61003	4.20	14704	6.40	62703	1.80	980	1570	72.40

## 6. MULTI-PLATE NOVA SPAN PROFILE ARCH

Culvert, storm sewers, low headroom and large opening. Bridge structures, stream enclosures. Aesthetic shapes and open natural bottoms for environmentally friendly crossings.

### Section Properties

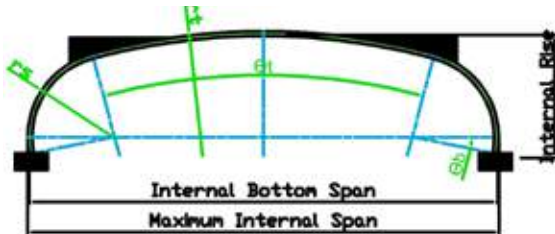

Table 24: Section Properties of Multi-plate Nova Span Low Profile Arch

Structure Number	Max Span (mm)	Bottom Span (mm)	Rise (mm)	Periphery (mm)	End Area (m <sup>2</sup> )	Top Radius $r_t$ (mm)	Side Radius $r_s$ (mm)	Top Angle $\theta_t$ (deg)	Side Angle $\theta_s$ (deg)	Bottom Angle Bellow Hor. $\theta_b$ (deg)	Top Step (mm)	Bottom Step (mm)
19 A 7	6029	5986	1570	7875	8.12	8500	11002	9.99	86.451	1.45	2902	89
24 A 7	7071	7024	1782	6050	10.59	8500	11503	7.88	82.791	1.73	4602	89
28 A 7	7927	7884	1951	9990	12.79	8750	120004	2.94	79.421	0.89	6072	90
28 A 10	8818	8765	2275	11400	17.11	12000	16003	1.34	84.711	0.38	4462	90
33 A 10	9857	9800	2488	12575	20.63	12000	16503	6.94	82.191	0.66	6182	90
38 A 10	10871	10808	2727	13750	24.58	12000	17004	2.53	79.771	1.03	8172	90
41 A 11	11705	11641	3070	14925	29.63	12000	19254	5.89	77.481	0.42	9492	90
47 A 11	12861	12789	3414	16335	35.69	12000	20005	2.67	4.62	10.92	12422	90
51 A 12	13816	13735	3859	17745	43.11	12000	22505	7.08	72.341	0.88	14582	90
56 A 12	14737	14656	4191	18920	49.42	12000	23506	2.67	69.291	0.62	17502	90



### Structural Design

If designed properly, the combination of structural steel and surrounding soil allows Multi-Plate to support extremely heavy loads. However, design assistance and recommendations can be specified to suit your project. Contact your **KBP** Products Technical Sales Representative for assistance.

### Design Process

The structural design process consists of the following :

1. Check Minimum allowable cover  
 The minimum allowable depth of cover is the largest of :
  - a. 0.6m (Refer to project specification)
  - b.  $(D_h/6) (D_h/D_v)^{1/2}$
  - c.  $0.4 (D_h/D_v)^2$

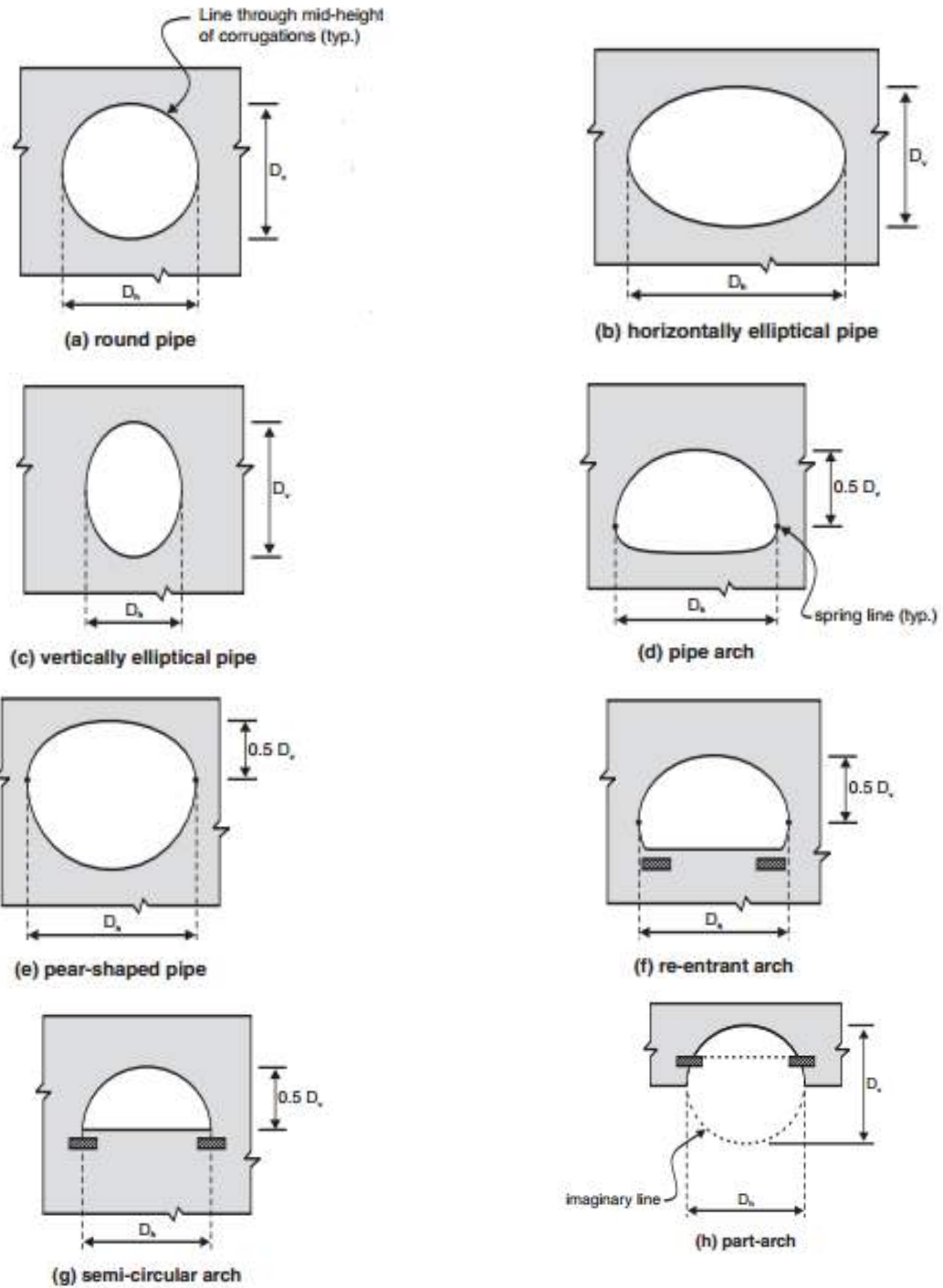

2. Calculate Dead Load Thrust

The dead load thrust in the walls due to the overburden (Dead) loads shall be calculated From :

$$T_D = 0.5 (1.0 - 0.1 C_s) A_f W$$

Where :

$T_D$  = Dead Load Thrust (kN/m)

$A_f$  = Arching Factor Used to calculated the thrust due to dead load in the wall, as define in Figure below

$C_s$  = Axial stiffness parameter

$$= 1000 E_s D_v / EA$$

$W$  = Dead weight of the column of material above the structure (kN/m)

$E_s$  = Secant modulus of soil stiffness (Mpa)

$D_v$  = Vertical dimension of the structure (m)

$E$  = Modulus of elasticity of the structure metal (Mpa)

$A$  = Cross sectional area of the corrugation profile (mm<sup>2</sup>/mm)

**Arching Factor,  $A_f$**

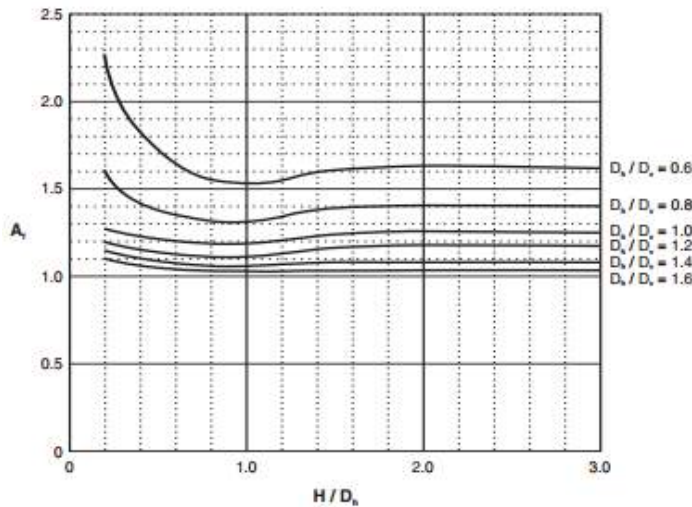

**Area used in the calculation of  $W$**

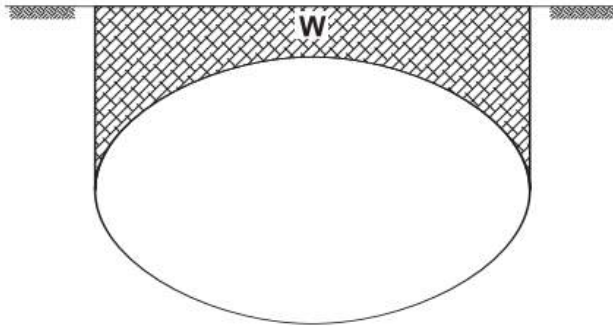

**Values of  $E_s$  for Various Soils**

Soil Group	Grain Size	Soil Types	Unified Soil Classification Symbol*	Standard Proctor Density **	Secant Modulus of Soil, $E_s$ (Mpa)
I	Coarse	Well Graded Gravel or Sandy Gravel	GW	85	6
		Poorly Graded or Sandy Gravel	GP	90	12
		Well Graded Sand or Gravelly Sand	SW	95	24
		Poorly Graded Sand or Gravelly	SP	100	30
II	Medium	Clayey Garvel or Clayeye-sandy Gravel	GC	85	3
		Clayey Sand or Clayey Gravelly Sand	SC	90	6
		Silty Sand or Silty Gravelly Sand	SM	95	12
				100	15

Note : \* According to ASTM D2487.92  
 \*\* According to ASTM D698-91



3. Calculate live load thrust

The live load thrust is assumed to be constant around the structure, and is given by the lesser of :

$$T_L = 0.5 D_h \sigma_L m_f$$

Or

$$T_L = 0.5 L_t \sigma_L m_f$$

- Where :
- $T_L$  = Live load thrust due to unfactored live load kN/m
  - $D_h$  = horizontal dimension (effective span)of the structure
  - $L_t$  = Distance between the outermost axles including the tire footprints + 2H
  - H = Height of cover
  - $\sigma_L$  = Uniformly-distributed pressure at the crown (top) of the structure resulting from the load distribution of the unfactored live load through the fill, kPa
  - $m_f$  = Modification factor for multi-lane loading

**Distribution Load : Truck**

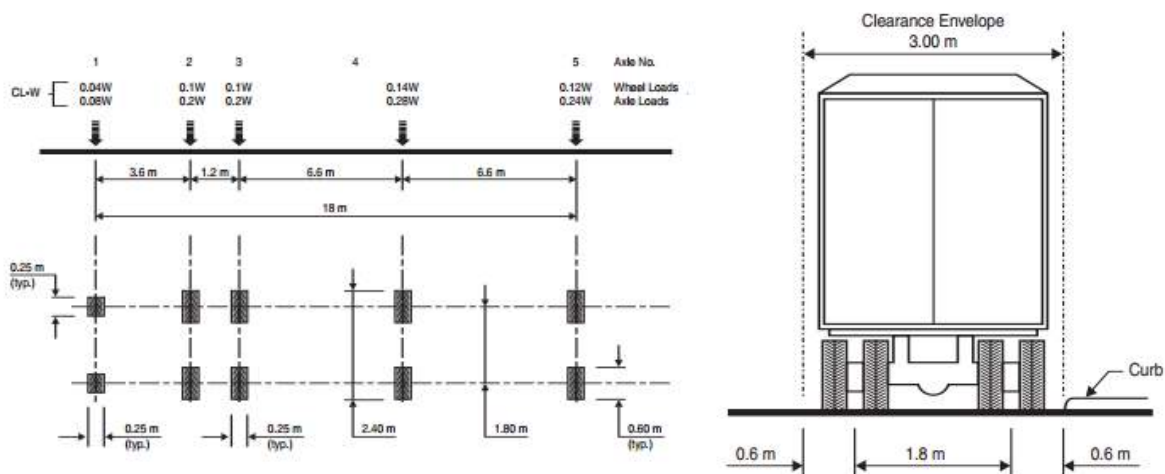

4. Earthquake Thrust

The additional thrust due to earthquake loading, is obtained from :

$$T_E = T_D A_v$$

- Where :
- $T_E$  = Thrust in the wall of a soil-metal structure due to earthquake loading, kN/m
  - $T_D$  = Thrust in the structure wall due to unfactored dead load, kN/m
  - $A_v$  = Vertical acceleration ratio due to earthquake loading = 2/3 the horizontal acceleration

5. Total Thrust

The thrust in the wall due to factored live loads and dead loads, is calculated according to the following equation :

$$T_f = \alpha_D T_D + \alpha_L T_L (1 + DLA)$$

The thrust in the wall due to factored earthquake and dead loads, is calculated according to the following equation :

$$T_f = \alpha_D T_D + T_E = (\alpha_D + A_v) T_D$$

- Where :
- $\alpha_D$  = Dead load factor, dimensionless
  - $\alpha_L$  = Live load factor, dimensionless
  - DLA = Dynamic load allowance expressed as fraction of live load

6. Calculate the compressive stress (**Not identified in here**)
7. Calculate the wall strength in compression (**Not identified in here**)
8. Check wall strength requirements during construction (**Not identified in here**)
9. Check wall strength of completed structures with deep corrugations (**Not identified in here**)
10. Check Seam strength & difference in plate thickness of adjacent plates (**Not identified in here**)
11. Check plate Radius of curvature (**Not identified in here**)



## MULTI PLATE

This section presents information of fundamental importance regarding installation and construction procedures including base preparation, unloading and assembly, and placement and compaction of the backfill. The emphasis is on corrugated steel pipe in embankment installation. For pipe in trench installation such as storm sewers, reference should be made to the equivalent standards and codes.

### Base Preparation

Pressure developed by the weight of the backfill and live loads is transmitted both to the side fill and the strata underlying the pipe. The supporting soil beneath the pipe, generally referred to as the foundation, must provide both longitudinal and lateral support. The portion of the foundation in contact with the bottom of the structure is referred to as the bedding. Depending upon the size and type of structure, the bedding may either be flat or shaped.

#### Soft Foundation

Evaluation of the construction site may require subsurface exploration to detect undesirable foundation material, such as soft material (muck) or rock ledges. Zones of soft material give uneven support can cause the pipe to shift and settle non uniformly after the embankment is constructed. Thus material of poor or non-uniform bearing capacity should be removed and replaced with suitable compacted fill to provide a continuous foundation that uniformly supports the imposed pressure. The bedding may then be prepared as for normal foundations. Hereby illustrates the treatment of soft foundations.

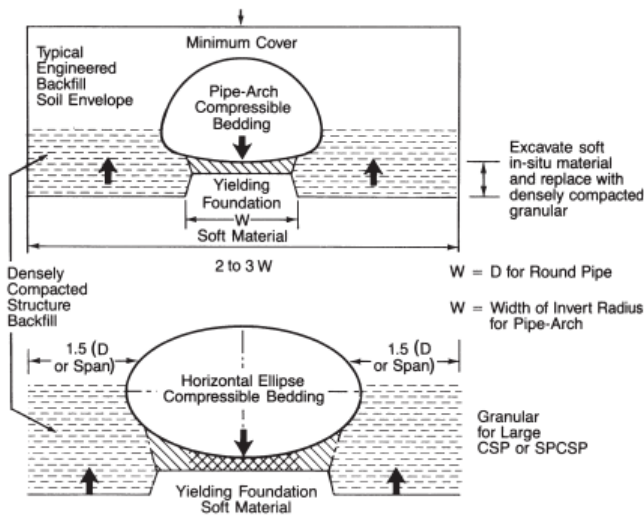

#### Rock Foundation

If rock ledges are encountered in the foundation, they may serve as hard points that tend to concentrate the loads on the pipe. Such load concentrations are undesirable since they can lead to distortion of the structure. Thus large rocks or ledges must be removed and replaced with suitable compacted fill before preparing the pipe bedding. Furthermore, when the pipe foundation makes a transition from rock to compressible soil, special care must be taken to provide for reasonably uniform longitudinal support. Hereby illustrates the treatment for rock foundations and transition zones.

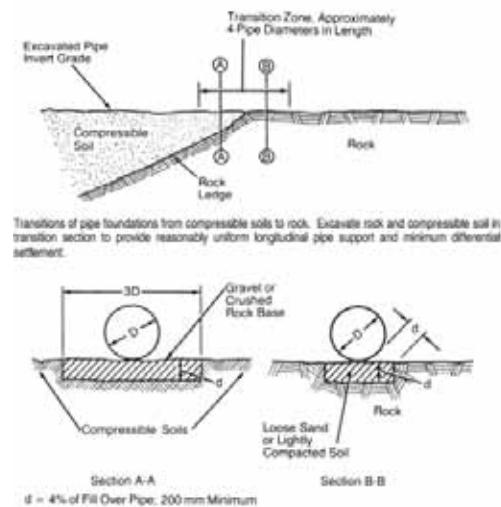

Note : Section B-B is applicable to all continuous rock foundation

#### Normal Bedding

With flat bedding, which is usually standard for factory-made round pipe, the pipe is placed directly on the fine-graded upper position of the foundation. Soil must then be compacted under the haunches of the structure in the first stages of backfill. The bedding concept for pipe-arch structures also relates to large diameter and underpass shapes. For these structure, the bedding should be shaped to the approximate contour of the bottom portion of the structure. Alternatively, the bedding can be shaped to a slight V-shape.

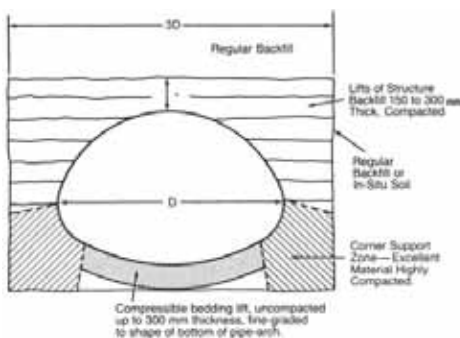

Typical Backfill envelope for pipe-arch or long-span structures

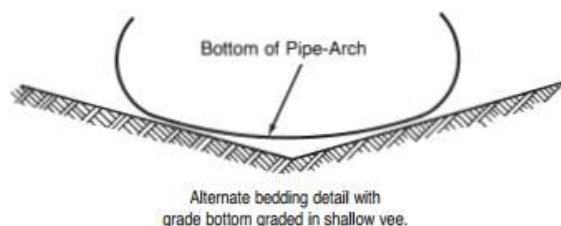

Alternate bedding detail with grade bottom graded in shallow vee.

## Unloading and Handling

Corrugated steel structures is relatively light weight and can be handled with light equipment. CSP should never be dumped, dragged or unloaded in a manner that would damage the coating or alter the shape of the CSP. Premature corrosion can start around the damage area if not repaired.

Plates for structural plate structures are shipped nested in bundles, complete with all plates, bolts and nuts necessary for erection. Included with shipment are detailed erections showing the order of assembly and the position of each plate.

Pre-sorting the plates as they are unloaded, on the basis of their radius and location in the structure, is important. All plates are clearly identified so that they can be easily sorted.

## Assembly

There are four basic methods by which structural Multi-plate can be assembled :

1. Plate by plate assembly The majority of multi-plate are assembled directly on the prepared bedding in a single plate by plate erection sequence, commencing with the invert, then the sides, and finally, the top. This method is suitable for any size of multi-plate structure.
2. Component sub assembly This is pre-assembly of components of a ring, away from bedding. The components are usually comprised of the bottom plates, the side plates and the crown plates. This method is suitable for most soil-steel bridge installations. Component sub-assembly is often more efficient than the plate by plate assembly method. It's main advantage is that it permits simultaneous progress at two different locations at the structure site. The figure on the right shown this method.
3. Pre-Assembly of Ring In this method, circumferential rings of round structures are assembled off-site. These rings or cans, are then transported to the assembly site for connection along their circumferential seams. A special technique is used to lap the end corrugations of one ring with those of its adjoining ring, to provide continuity in the assembly.
4. Complete Pre-Assembly Pre-assembly of the complete structure can be done either at the factory or at the jobsite. The factory pre-assembled method is used for relatively small span installation, this application being limited by shipping size. The field pre-assembly method is selected for structures to be lifted intact or to be skidded onto a prepared foundation and bedding.

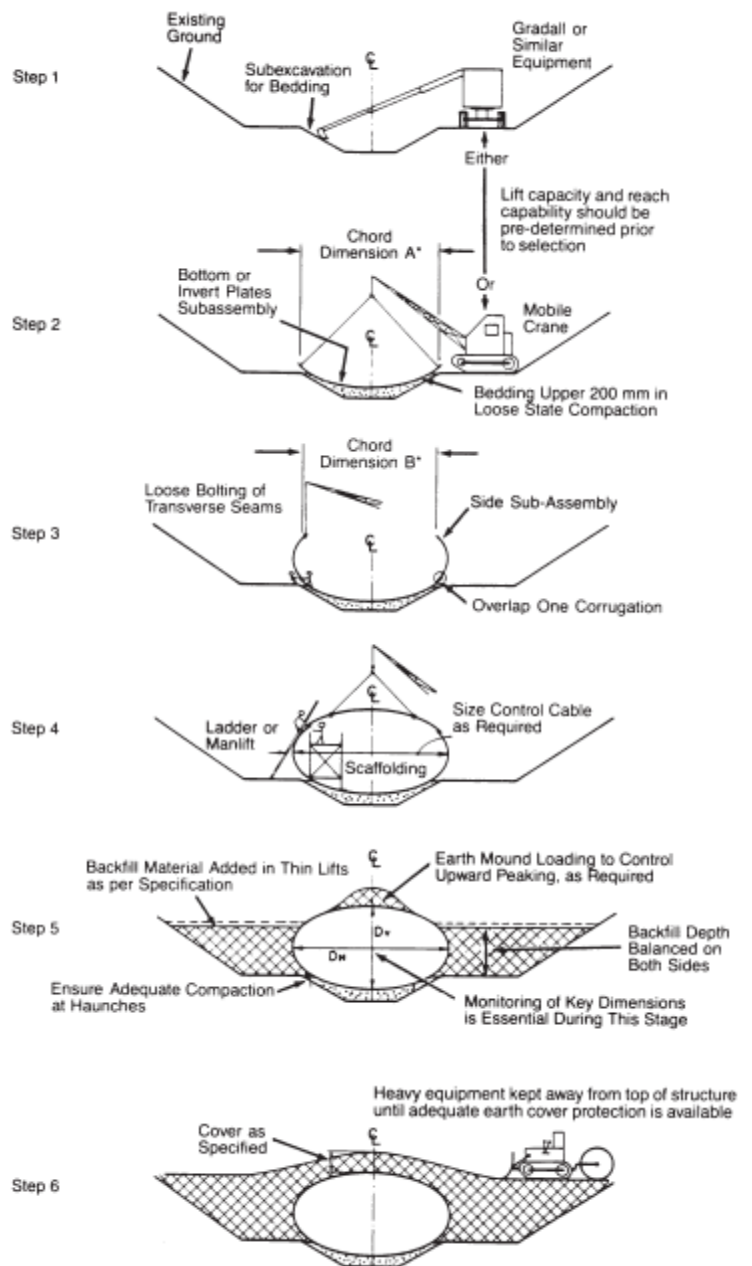

When all bolts are inserted, tighten nuts. Nuts should be finally tightened. Maximum bolt torque refer to Table below :

Table 25 : Bolt Torque

Plate Thickness (mm)	Bolt Torque (Nm)
1,2 - 3,5	20 ± 5
2,5-5	310 ± 40
6-8	395 ± 25

As a principle rule for backfilling, approved granular materials should be used to construct an engineered backfill envelope. It should be placed in maximum 200mm lifts to ensure that specified compaction levels are attained.

### Backfill Guidelines

- Material is placed loose in 200mm lifts
- Compact to 95% proctor Dry density
- Compact at optimum moisture content
- Lifts to be placed in a balanced manner on both sites of structure
- No more than 400mm difference in top of backfill elevation from side to side of structure
- First 1.5m above structure to be spread using small (typically D4) equipment
- First 600mm above structure to be lightly compacted (walk-behind equipment)
- Large vibratory equipment to be kept at least 1.5m away from walls of structure
- Dimensions of critical backfill zone are as per KBP drawings

### Typical equipment required for backfilling in critical backfill zone

- Excavator(s) with adequate reach to place backfill
- Small tracked/wheeled equipment for spreading (e.g. d4/Jd450/Bobcat)
- Walk-behind compactor (e.g. Bomag BW75)
- Vibrating plate tampers
- Ride on compactor up to 15 tonnes for larger areas (Not permitted within 1.5m of structure)
- Tracked (d6) equipment for spreading material when backfill is more than 1.5m above structure
- Water truck or water supply
- Hand tools as appropriate

Notes :

- See KBP backfill drawings for complete instructions
- Material to be granular with angular grains
- Sieve analysis to fall within the stated envelope
- Material to be well graded; uniform, skip or gap grading is not permitted

### Typical Backfill Gradation Requirements for Critical Backfill Zone

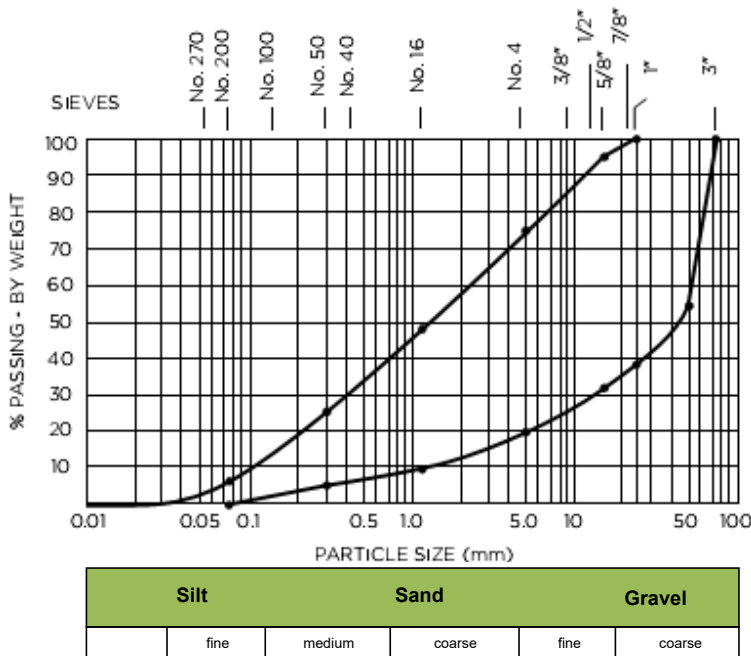

Table 26

Sieve Size (mm)	Percent Passing Lower Limit	Percent Passing Upper Limit
75	100	100
59	55	100
25	38	100
16	32	95
5	20	75
12	10	48
0.3	5	25
0.075	0	7

### Temporary Construction Cover

All construction shall be protected with sufficient cover before permitting heavy construction equipment to pass over them during construction in accordance with the table at right

Table 27 : Min. Temporary cover for construction (mm)

Span (mm)	80-220	Axle Loads (kN)		480-660
		220-330	330-480	
300-1000	600	750	900	900
1200 - 1800	900	900	1000	1200
1900 - 3000	900	1000	1200	1200
3200 - 3600	1000	1200	1350	1350



## Trench Installation

Pipe Installation within cut trenches shall not begin until the bedding has been properly formed over a suitable foundation. The trench should be kept to the minimum with needing to safely placed pipe and adequately compact side-fill. In no case shall the trench width be less than 1.25times the pipe span plus one 300mm unless provisions are in place for alternate backfill and backfilling methods.

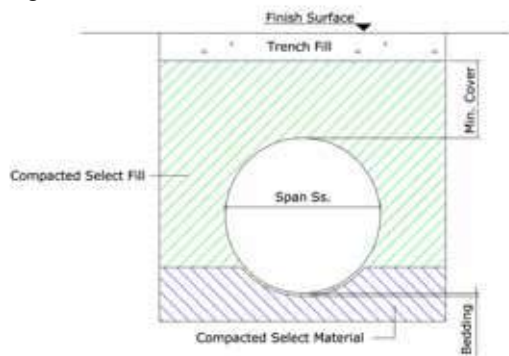

## Thrust Beam

Thrust beams run the full length of **Multi-Plate SUPERSPAN structure**. The thrust beam transfers imposed dead and live load pressure from the top plates into the compacted soil on each side of the structure.

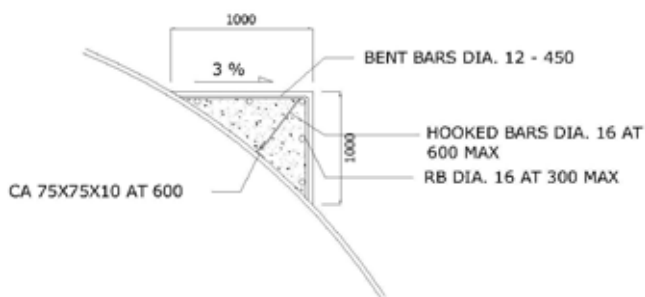

## Embankment Installation

Pipe installation within the limits of embankment Construction shall not begin until the fill operation has progressed to an elevation not less than the proposed invert plus one-half the rise of the pipe, and to a width that encompasses at least two pipe spans on each side of the pipe. Once the fill operation has reached these limits a trench may be excavated in the constructed embankment and the installation may progress in accordance with the trench installation procedure

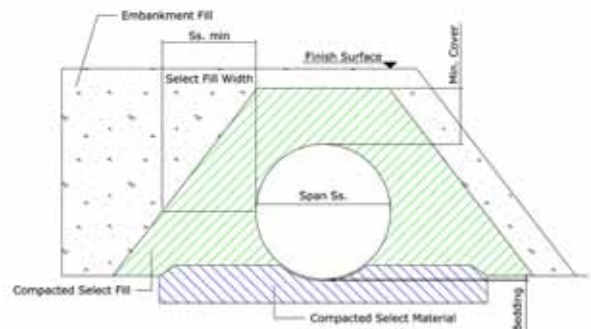

## Ring Beam

A concrete collar or 'Ring Beam' may be required to finish skewed or beveled structures. Hook Bolts are supplied by Atlantic Civil Products and may also be used as a means to tie structures to vertical concrete headwalls.



## Nova Span Concrete Cap

The design of the concrete cap reinforcement layout is supplied By KBP

## Shape Control

Shape control refers to controlling the symmetry of the structure during backfill, by control of the backfill operation.

As a general rule, deflection in any direction, measuring greater than 2% from original shape, should not be allowed during the backfill operation.

The sides of a flexible structure will naturally push outward, compacting the side fills and mobilizing their passive resistance. As the sides go outward, the top moves downward.

This downward vertical small is normal. With reasonable backfill practice, any flexible underground structure can be expected to deflect vertically. With excellent practice, the deflection is usually less than 2% of the rise dimension.

If the side-fills are placed loose and/or not compacted, the sides of a flexible structure will move outward to a point where the allowable vertical deflection will be exceeded and pipe failure may occur by buckling. For smaller diameter round pipes, experience has shown that complete vertical (Snap-through) buckling failure may occur at about 20% vertical deflection.

Positive soil arching usually occurs over flexible structures with depths of cover greater than the pipe diameter. If the column of fill over the pipe settles slightly more than the side-fills, some of weight of this column is effectively transferred to the side-fills through shear. In the process, a positive soil arch is mobilized, which reduces the effective load on the structure.

**Once again, correct installation and backfilling are required for this occur.**

# FLEX BEAM GUARD RAIL





## Introduction

Roadside barriers have been developed over the years to safely redirect vehicles that leave the roadway. Many different rigid, semi-rigid and flexible designs for roadside barriers have evolved. The most common system consists of a steel w-beam rail supported on steel posts with end treatments and transitions of various designs using similar materials.

KBP Civil Products' Flex-beam guardrail's uniformly high resistance to impacts is assured by its continuous flexible beam action. This prevents dangerous pocketing and minimizes the ride down deceleration experienced by the vehicle and its occupants.

The high visibility of Flex-beam guardrail creates driver confidence. This is an intangible but exceedingly important factor. At night or in fog conditions, the excellent visibility of Flex-beam guardrail highlights the limit of safe travel and reduces dangerous center-line crowding.

The pipe railing is built as a standard profile to keep the price low. The design focuses on aesthetics so KBP pipe railing is mostly used where the demands for attractive and see-through product are high, for example close to traffic interchanges, rivers or cultural sites. Because of its closed profile and ingenious mount, Pipe railing is the simplest and quickest pipe railing to install. The post fastening bolt is already fitted on delivery thus reducing assembly time.

## Specification

Guardrail is manufactured in accordance with the following specification :

<ul style="list-style-type: none"> <li>• SNI 07-0950-1989</li> <li>• SNI 03-2446-1991</li> <li>• SNI 07-7033-2014</li> <li>• SNI 0.3-6764-2002</li> </ul>	<ul style="list-style-type: none"> <li>• AS/NZS 3845:1999</li> <li>• AS/NZS 4680:2006</li> </ul>	<ul style="list-style-type: none"> <li>• AASHTO – M180</li> <li>• AASHTO Roadside Design Guide (RDG)</li> </ul>	<ul style="list-style-type: none"> <li>• ASTM A741</li> <li>• ASTM A123</li> <li>• ASTM A588</li> <li>• ASTM A563</li> </ul>
-----------------------------------------------------------------------------------------------------------------------------------------------------------	--------------------------------------------------------------------------------------------------	-----------------------------------------------------------------------------------------------------------------	------------------------------------------------------------------------------------------------------------------------------

## Benefits

### Shock-absorbing Qualities

KBP's Guardrail is a widely-accepted highway safety product, used in Indonesia over as a safety system providing not only traffic delineation, but also protection in the event of vehicular loss of control. Installed in the median of a divided highway, or along the curb lanes of highways and two-lane roads, the continuous steel guardrail absorbs the shock of vehicle impact and guides the vehicle in the direction of the traffic flow. The net result of this system is to reduce the tendency for out-of-control vehicles to rebound into the path of following or on-coming traffic.

### Longitudinal strength

In addition to its ability to absorb impact at steep angles of incidence, the continuous nature of guardrail also provides great longitudinal strength, thus minimizing the chance of a break-through occurrence.

### Low maintenance

Once installed KBP's guardrail requires minimum maintenance. All steel components are hot-dip galvanized after fabrication. Posts are either of pressure-treated wood or of galvanized steel. In heavy salt-use areas, periodic washing of the guardrail will prolong the useful service life. As service life of at least thirty years can be expected under most conditions

### Economics

KBP's guardrail offers economy not only in the material costs of the system, but also in installation costs. No specialized equipment or heavy lifting equipment is required for the majority of installations. Different post configurations can be supplied for installing Flex-Beam in confined spaces, on bridge decks or on bridge approaches. Removal and replacement of damaged sections can be easily undertaken due to the lightweight, modular layout and bolted connections used. Significant quantities of rail can be carried on standard trucks.

### Acceptance

KBP's guardrail has been in conformity with the highway departments and municipalities across Indonesia.

## Versatility

- Application include parking lots, single and multi-lane highways, bridges and bridge approaches.
- Guardrail systems can be tailored to any application.
- Shop-manufactured rail can be radiused to fit convex and concave curves.
- Rail systems can be designed with wood or steel posts and offset blocks.
- Numerous end treatments are available to meet all design requirements and standards.
- Post to rail ratios can be varied to meet safety requirements.
- Rail thickness is available in 2.7mm (12ga)

# FLEX-BEAM GUARDRAIL Specification & Cross Section

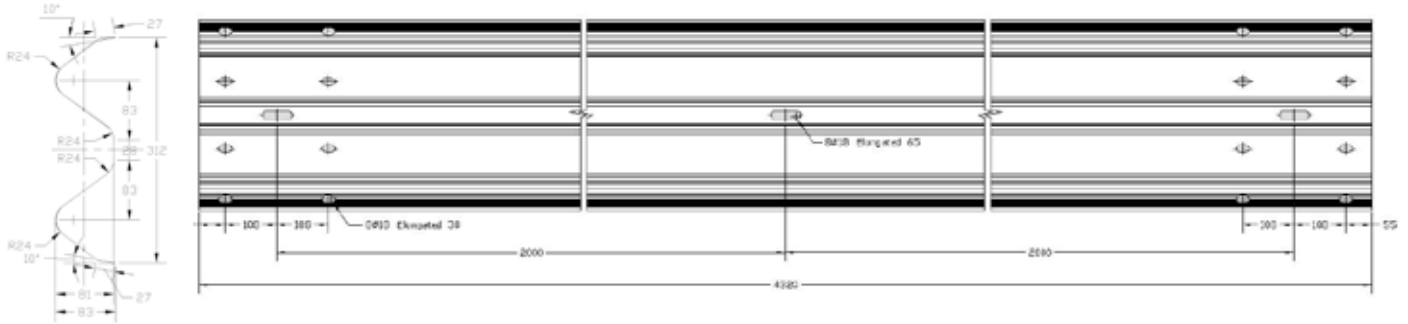

## Barrier Deflection

The expected deflection of the barrier should not exceed the available room to deflect. If the available space between the hazard and the barrier is not adequate, then the barrier can be stiffened in advance of, and alongside the hazard. Commonly used methods to reduce deflection of Flex-beam guardrail include reducing the post spacing.

### Rail

Thickness (mm)	2.7
Beam width, minimum (mm)	312
Beam Depth, minimum (mm)	83
Cross – Sectional Area (mm <sup>2</sup> )	973 980
Section Modulus (mm <sup>2</sup> )	22 778

### Post

Thickness (mm)	4.5 ; 6
Height (mm)	1800
Dimensions	176 x 72

### Blocking

Thickness (mm)	4.5 ; 6
Height (mm)	350
Dimensions	176 x 72

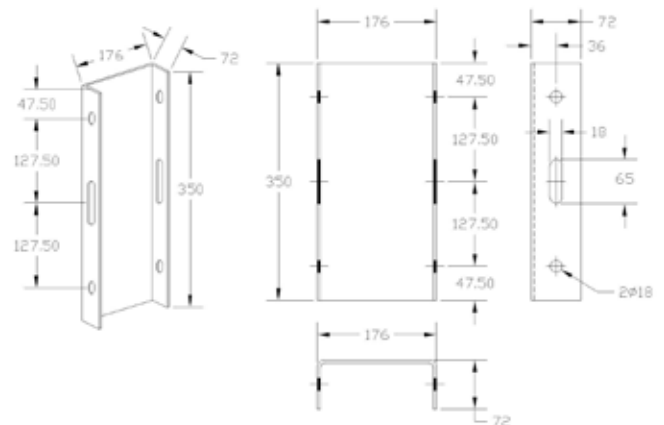
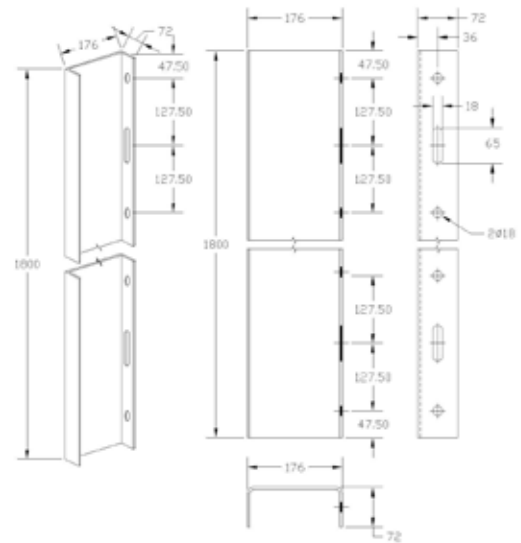

### Note :

Some client may use different specification.  
Our engineers are trained to work with you for your design challenges



## End Terminals and Transitions

Guardrail end terminals are designed to provide a soft gating impact to prevent the end rail from spearing an impacting vehicle. Terminals also introduce tensile and flexural strength necessary to ensure redirection performance of the length-of-need section. Transitions are required when Flex-beam guardrail is terminated at a bridge abutment or a concrete parapet. The purpose of a transition is to smoothly increase the stiffness of the approach guardrail from the more flexible to the less flexible system.

### End Shoes

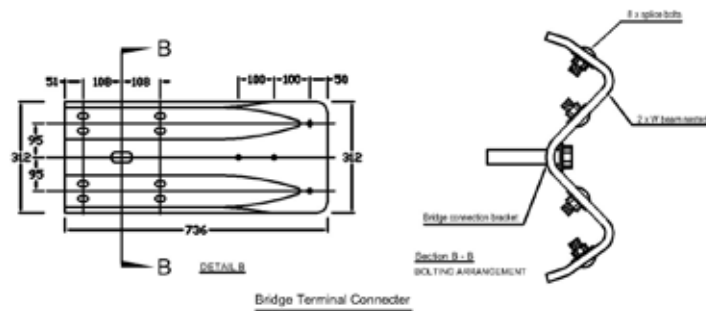

### Fish Tail Terminal Section

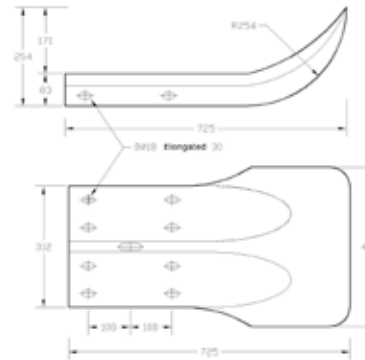

### Bullnose Terminal Section

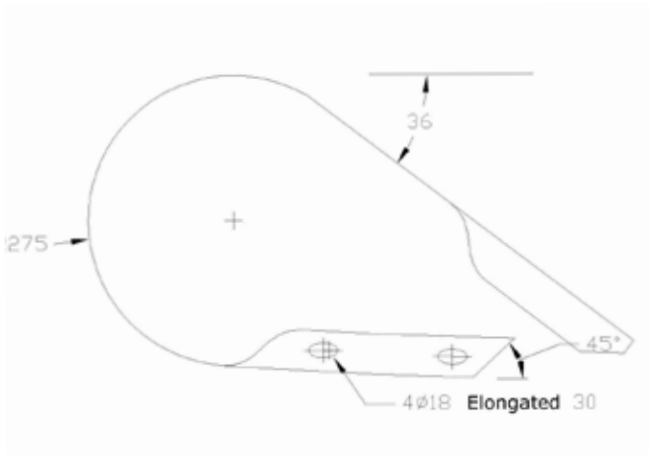

### Nose Terminal Section

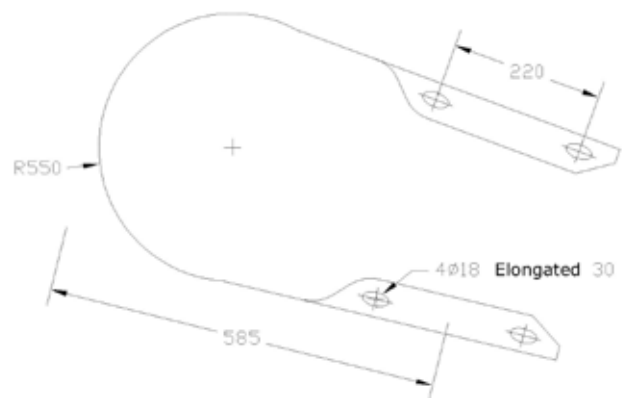

### Fasteners

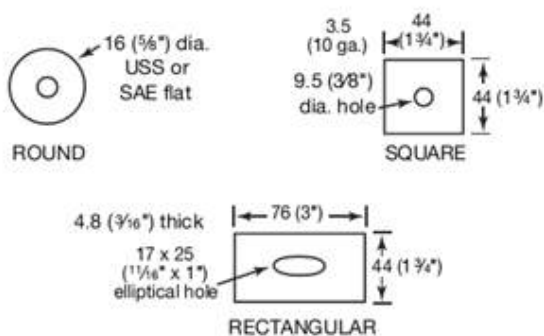

#### Washers

Hardware is available hot-dip galvanized or mechanically galvanized.

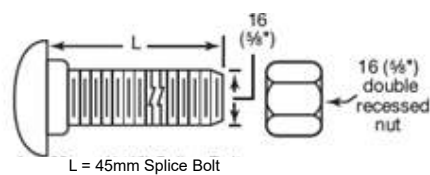

#### Button Head Bolts & Hex Nuts

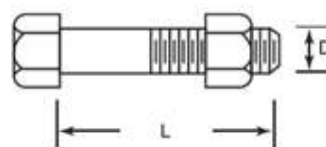

#### Hex Head Bolts & Hex Nuts



## Installation

### a. Site Preparation

Flex-beam guardrail should be located at least 600mm (measured from back of post) in front of embankments that require shielding. This distance is required to provide proper post support. The approach terrain to the barrier must be level. Grading to 1:20 is preferable and 1:10 maximum slope should be present. Steeper slopes can result in the vehicle impacting the barrier at other than the design height.

### b. Installation Sequence

The following written instructions should be read in conjunction with KBP Civil Products' drawings:

1. Ensure the area has been inspected for underground hazards and that suitable traffic control is in place.
2. Post locations are marked ensuring the hazard to be protected is located outside the expected dynamic deflection of the barrier.
3. The post is orientated with no post edges Presented towards the traffic.
4. Posts are driven directly into the ground and should be vertical. (The post installation process shall not cause damage to the post, such that it reduces the effective operation of the safety barrier or its design life, or introduces sharp tearing edges, nor shall it cause damage to pavement). Alternately, a hole can be augured and the post placed in the hole. The posthole is then backfilled with the material that was excavated. Material should be placed in layers and suitably compacted to not less than the density of the surrounding layers.
5. Blocking pieces are then attached to the posts using M16 hex. head bolts. The function of the blocking piece is to prevent wheel snagging and vehicle vaulting.
6. Rails are attached to the blocking pieces and are spliced using mushroom head bolts. The holes in the rails for attachment to the blocking pieces are slotted to allow for tolerances in post spacing.
7. Rails are spliced together at every second post using M16x32mm mushroom head bolts. Rails are orientated so that no leading edges are presented to the traffic face. At post locations where there is not a rail splice, a stiffener piece is inserted behind the rail. Washers are NOT used.
8. It is recommended that posts be installed only a few metres ahead of rail assembly to ensure correct post spacing and alignment. On curves, the rails can be used as a template and laid on the ground to determine post locations.

### c. Curving

FLEXBEAM guardrail may be shop curved to fit any radius from 2.4m to 46m. Curves in excess of 46m radii do not require shop curving as the lap joint accommodates itself to such installations. Rail may be curved either concave or convex to the traffic ace and can be part curved along its length to suit your needs.

Measuring Curvature :

1. Depending on your length of rail, mark along your arc at 4m interval.
2. Measure the corresponding chord length (C) – Refer to Figure at right.
3. Measure the corresponding center offset (H) – Refer to Figure at right.
4. Use the values for C and H to select the radius from Table at right
5. Determine the curvature orientation from Figure at right.

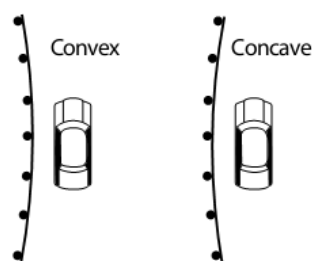

Radius (m)	$\Theta$ (deg)	C (mm)	H (mm)
2.4	95.5	3553	786
3	76.4	3710	642
4	57.3	3835	490
5	45.8	3894	395
6	38.2	3926	330
7	32.7	3946	284
8	28.7	3958	249
9	25.5	3967	221
10	22.9	3973	199
12	19.1	3982	166
14	16.4	3986	143
16	14.7	3990	125
20	11.5	3993	100
24	9.5	3995	83
28	8.2	3997	71
32	7.2	3997	62
35	6.6	3998	57
40	5.7	3998	50
45	5.1	3999	44

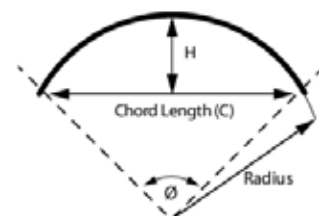



## PIPE RAILING

Bridge pipe railing passes the test for the highest performance class. This parapet has two pipes based on standard profile.

The parapet is airy and aesthetically pleasing and, for reason, it is used where there is a requirement for a tastefully-designed traffic environment with good overall visibility, for example, at traffic interchanges, water conservation areas, bridges over railways, watercourses or cultural sites.



**Note :**

Some client may use different specification.

Our engineers are trained to work with you for your design challenges

## Installation

### On Bridge

1. Safety-walks range in width from 450mm to less than 1200mm. On existing freeway and interstate structures with safety-walks, where it is not feasible to remove the safety-walk and provide a concrete, barrier-shaped parapet, the pipe railing shall be carried across the structure along the gutter line. However, on existing freeway and Interstate ramps where the posted speed or advisory speed is 40 mph or less and the safety-walk is 750mm or less in width, it is not necessary to carry guide rail across the structure since vaulting is not likely to occur.
2. Where the roadway approaching a structure has curbs or berms, the pipe railing mounting height on the structure should be measured from the top of curb and rub rail is required. However, on long structures, the pipe railing mounting height may be measured from the gutter line provided the face of pipe railing is flush with the curb face. In this case rub rail will not be required. The pipe railing mounting height should be measured from the gutter line on those structures where the approach roadway is an umbrella section and the face of pipe railing is set flush with the curb face on the structure. Where guide rail is set flush with the curb face and the mounting height is measured from the gutter line, rub rail is not required.
3. Where there is a difference in the offset to the approach pipe railing and the offset to the bridge parapet, the approach pipe railing should be flared at 15:1 prior to the standard pipe railing transition to the bridge parapet.
4. Attachment of pipe railing to bridges and structures shall be in accordance with the Department's Standard Roadway Construction Details, revised or modified Standard Details or Special Details. The designer shall specify at each location on the construction plans the pipe railing attachment detail to be used.
5. Where there is considerable pedestrian traffic, the pipe railing may be set flush to the curb face to physically separate pedestrians from vehicular traffic if feasible.

### At Fixed Object

Where pipe railing is used to shield an isolated obstruction, it is most important that the pipe railing be located as far from the traveled way as possible to minimize the probability of impact. The distance from the back of the rail element to the face of obstruction should desirably be 1200mm. or greater, if less than 1200mm must be used, the pipe railing system must be modified. If the pipe railing in advance of the obstruction is to be flared, no portion of the flare should be within the modified section of pipe railing.



# STREET LIGHTING POLE

## Introduction

Our street lighting columns are designed and manufactured for durability, corrosion resistance, and visual appeal. We begin with the highest-quality materials for our steel designs to fabricate poles and supports that meet your specifications and exceed your expectations for street lighting and a number of other applications.

## Features

- Hot dip galvanized internally and externally
- Environment Friendly
- Joint Less, Single piece construction
- Light weight, low handling cost
- Ease of maintenance
- Ease of Installation
- Long life
- Strength

## Technical Specification

- Octagonal tapered column
- Wind Speed : 35m/s
- Conforms to standards :
  - Pole Design : ASTM A123
  - Material : JIS G3101 SS400 - ASTM A36
  - Welding : SNI 03-1729, AWS D1.1
  - Galvanizing : SNI 07-7033, ASTM A-796

## Technical Guide

Poles of various types are erected in road reserves and beside roads. Lighting poles are an essential part of the road infrastructure and their location is defined by the technical requirements of the lighting design. Poles such as overhead electricity poles are placed in the road reserve for the convenience of the electricity utility and their location must be determined by the safety requirements of the road.

No unnecessary poles should be erected in the road reserve. Those that are necessary should be located as far from the travelled way as possible and at least outside the clear zone unless located behind a roadside barrier erected for another reason.

In urban areas on kerbed roads, poles should be placed as far behind the kerb as possible. If it can be achieved, poles should be located on the property side of the footpath rather than the past practice of just behind the kerb.

Non-yielding poles without barrier protection should not be erected at locations where they may be more vulnerable such as the following:

<ul style="list-style-type: none"> <li>• adjacent to horizontal curves with a speed value less than 80% of the 85th percentile speed of the element</li> <li>• on most traffic islands (particularly small ones) at intersections</li> </ul>	<ul style="list-style-type: none"> <li>• on narrow medians;</li> <li>• adjacent to road pavements that may become slippery under adverse conditions</li> <li>• in gore areas adjacent to off ramps (poles in gore areas should be avoided).</li> </ul>
<p>When a pole must be erected in the road reserve, the options for treatment are, in order of preference:</p> <ul style="list-style-type: none"> <li>• locate the pole outside the clear zone</li> <li>• make the pole a breakaway or frangible design where appropriate</li> <li>• provide a suitable roadside barrier</li> </ul>	<p>Circumstances where a breakaway design may not be appropriate are:</p> <ul style="list-style-type: none"> <li>• in locations where regular parking or other slow speed activity may result in accidental dislodgement of the poles</li> <li>• in narrow medians where the falling pole would not fall clear of the running lanes</li> <li>• in areas where the fall of the pole would foul overhead electricity conductors.</li> </ul>

## Option

- Height from 7m to 14m
- Flange mounted type
- Variable arm length from 2m to 2.3m with single or double arm
- Variable spigot size (Refer technical data sheet on the next page)

## Application

- Highway
- Roadway
- Residential Subdivisions
- Commercial development



## Single Ornament ( Parabola )

Table 28

Nominal Height (m)	Length of Arm (m)	SQ (mm)	C - C (mm)	Thickness (mm)	∅ (mm)	L (mm)	UGL (mm)	H (mm)	I (mm)
7	2.1	300	220	16	20	450	305	305	150
8	2.1	300	220	19	20	450	305	450	300
9	2.1	300	220	19	20	450	310	450	300
10	2.1	335	260	19	25	570	610	450	300
11	2.1	400	300	19	25	570	610	450	300
12	2.1	400	300	19	25	570	610	450	300
13	2.3	400	300	19	25	570	610	450	300
14	2.3	400	300	22	25	600	610	450	300

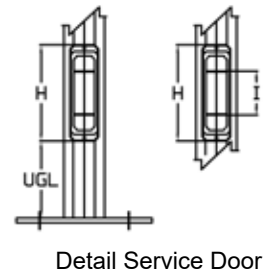
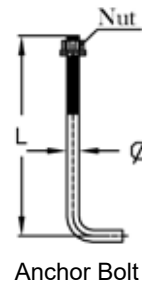
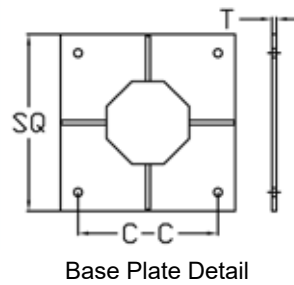
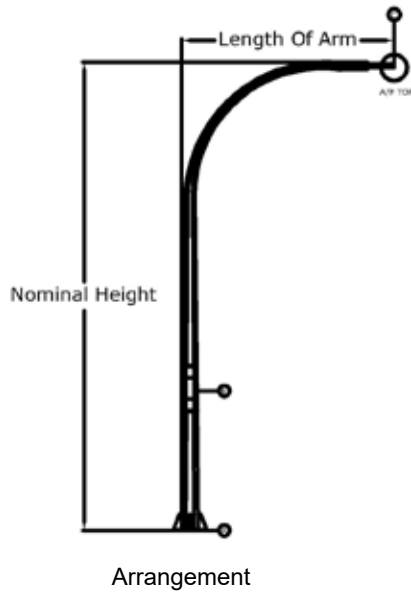

## Single Ornament ( T )

Table 29

Nominal Height (m)	Length of Arm (m)	SQ (mm)	C - C (mm)	Thickness (mm)	∅ (mm)	L (mm)	UGL (mm)	H (mm)	I (mm)
7	2.0	300	220	16	20	450	305	305	150
8	2.0	300	220	19	20	450	305	450	300
9	2.0	300	220	19	20	450	310	450	300
10	2.0	335	260	19	25	570	610	450	300
11	2.0	400	300	19	25	570	610	450	300
12	2.3	400	300	19	25	570	610	450	300
13	2.3	400	300	22	25	570	610	450	300
14	2.3	400	300	22	25	600	610	450	300

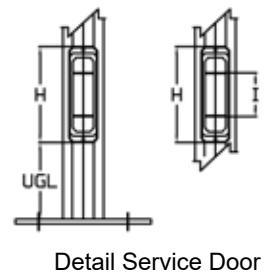
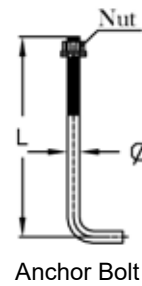
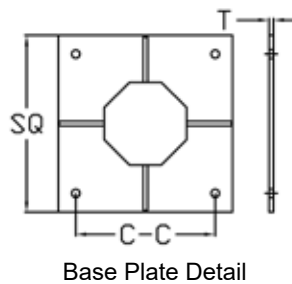
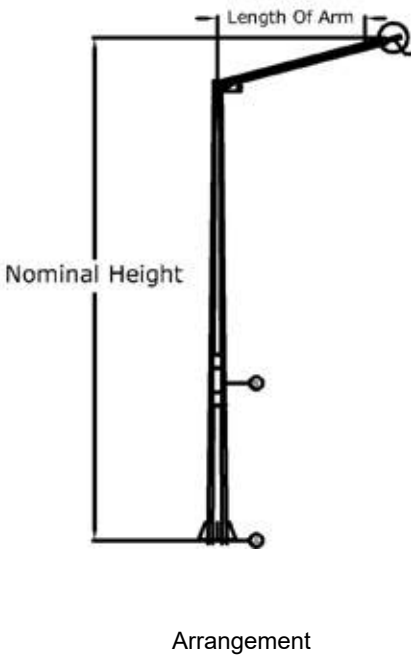

## Double Ornament ( Parabola )

Table 30

Nominal Height (m)	Length of Arm (m)	SQ (mm)	C - C (mm)	Thickness (mm)	Ø (mm)	L (mm)	UGL (mm)	H (mm)	I (mm)
7	2.1	400	300	16	22	570	305	305	150
8	2.1	400	300	19	22	570	305	450	300
9	2.1	400	300	19	22	570	310	450	300
10	2.1	400	300	19	25	570	610	450	300
11	2.1	400	300	19	25	570	610	450	300
12	2.1	400	300	19	25	570	610	450	300
13	2.3	400	300	22	25	570	610	450	300
14	2.3	400	300	22	25	600	610	450	300

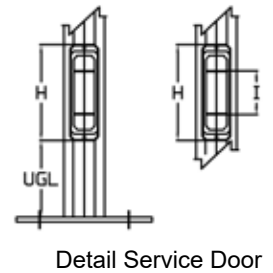
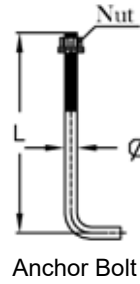
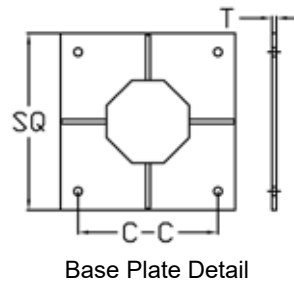
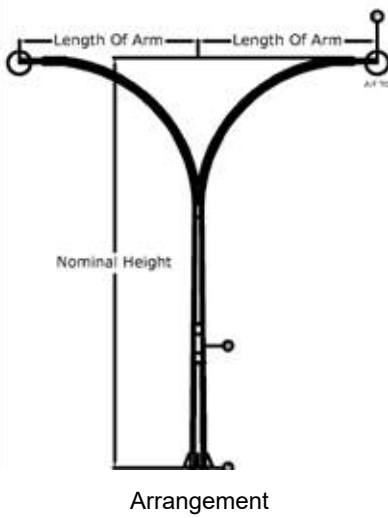

## Double Ornament ( T )

Table 31

Nominal Height (m)	Length of Arm (m)	SQ (mm)	C - C (mm)	Thickness (mm)	Ø (mm)	L (mm)	UGL (mm)	H (mm)	I (mm)
7	2.0	300	220	16	20	450	305	305	150
8	2.0	300	220	19	20	450	305	450	300
9	2.0	300	220	19	20	450	310	450	300
10	2.0	335	260	19	25	570	610	450	300
11	2.0	400	300	19	25	570	610	450	300
12	2.3	400	300	19	25	570	610	450	300
13	2.3	400	300	22	25	570	610	450	300
14	2.3	400	300	22	25	600	610	450	300

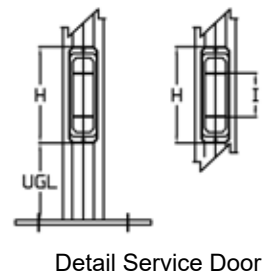
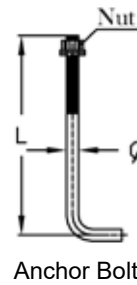
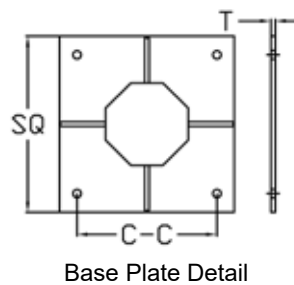
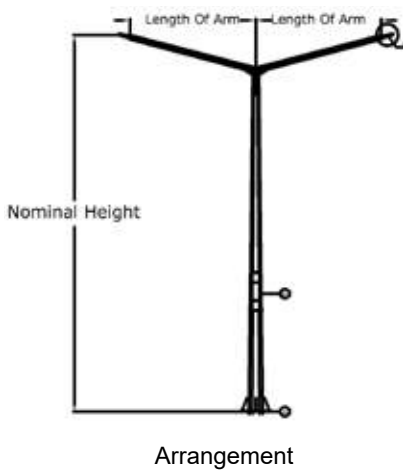

## Installation

The lighting pole shall be provided with 4 "L-Type" anchor bolts. For anchor bolt minimum diameter, length and projection details, see table above. Each anchor bolt shall be supplied assembled with (2) nuts, (2) flat washers and (1) split lock washer. All anchorage hardware shall be partially galvanized.

# CUSTOM FABRICATION





## CUSTOM DESIGN

The ingenious and effective use of Corrugated Steel Pipe in a diverse range of applications is testimony to the product's versatility. Urban development, confined spaces and time pressures have led to the necessity for fast construction methods that minimized the need for curing of in-situ concrete construction. The unique prefabricated design versatility offered by Corrugated Steel Pipe increases the scope of possible solutions and provides an edge for competitive civil construction. Corrugated Steel can be manufactured to incorporate the following special features:

- Variation in horizontal alignment
- Hydraulic drop structures
- Pipe junctions, bends and bifurcation
- Beveled and skewed ends
- Access risers with optional internal ladders
- Sediment pits
- Pump pits
- Trash racks/litter screens
- Inlet/outlet connections
- End walls/bulkheads
- Stock pile feeder collars
- Mine portal refuges
- Hanging conveyor and service supports
- Perforated drainage pipes
- Ventilation pipes

KBP Civil Products' team of experienced engineers would be pleased to assist you in developing special conceptual and detailed design solutions.



# INSTALLATION SERVICES



**KEMENTERIAN PERHUBUNGAN  
DIREKTORAT JENDERAL PERHUBUNGAN DARAT**

GEDUNG KARYA  
JL. MERDEKA BARAT NO. 8  
JAKARTA 10110

TELP (021) 3506138  
3506129, 3506145,  
3506143, 3902220

FAX  
021 3507202, 3506128,  
3506144, 3506143, 3902179

email  
hubdat@hubdat.web.id

Home Page  
www.hubdat.web.id

**KEPUTUSAN DIREKTUR JENDERAL PERHUBUNGAN DARAT  
NOMOR SK. 4062 /AJ.003 /DJPD/2016**

TENTANG

**TANDA DAFTAR BADAN USAHA PENYEDIA BAHAN PERLENGKAPAN JALAN (TD - BUPBJ)**

Diberikan Kepada:

Nama Perusahaan : PT. KARUNIA BAJA PERSADA

Alamat : Jl. Raya Narogong KM 6, No. 75, Kota Bekasi, Jawa Barat

No. Telp/ Fax : Telp. 021 - 82400790 / Fax. 021 - 22103215

Penanggung Jawab : ADE DARMAWAN

Jabatan : Direktur

Klasifikasi Bidang : Alat Pengendali dan Pengaman Pengguna Jalan

Subbidang : Pagar Pengaman

Keterangan : -

Berlaku sampai dengan : 5 September 2018, dengan ketentuan akan ditinjau kembali apabila ternyata dikemudian hari terdapat kekeliruan didalam penetapannya.

Kewajiban Badan Usaha Penyedia Bahan Perengkapan Jalan tercantum di balik TD - BUPBJ ini

Ditetapkan di Jakarta  
pada tanggal 5 September 2016

**DIREKTUR JENDERAL PERHUBUNGAN DARAT  
DIREKTOR LALU LINTAS PERHUBUNGAN DARAT**

*BANJUNYUNianto*  
**BANJUNYUNianto, ATD., M.Eng.Sc.**  
Panglima Utama Muda (IV/c)  
NIK: 19650606 198803 1 001

No Registrasi  
PB5332016

KARUNIA BAJA PERSADA



• strength and innovation •

**PT KARUNIA BAJA PERSADA**

Jl. Raya Narogong Km. 6, No. 75, Kampung Rawa Roko RT 03 / RW 02  
Kelurahan Bojong Rawa Lumbu, Kecamatan Rawa Lumbu  
Kota Bekasi, Jawa Barat 17116 Indonesia

 021 - 82400790

 021 - 22103215

 sales@ptkbp.com

 www.ptkbp.com



**Corrugated Steel, Flex Beam Guardrail, Steel Pole, Pipe Railing.**